

TalentMW

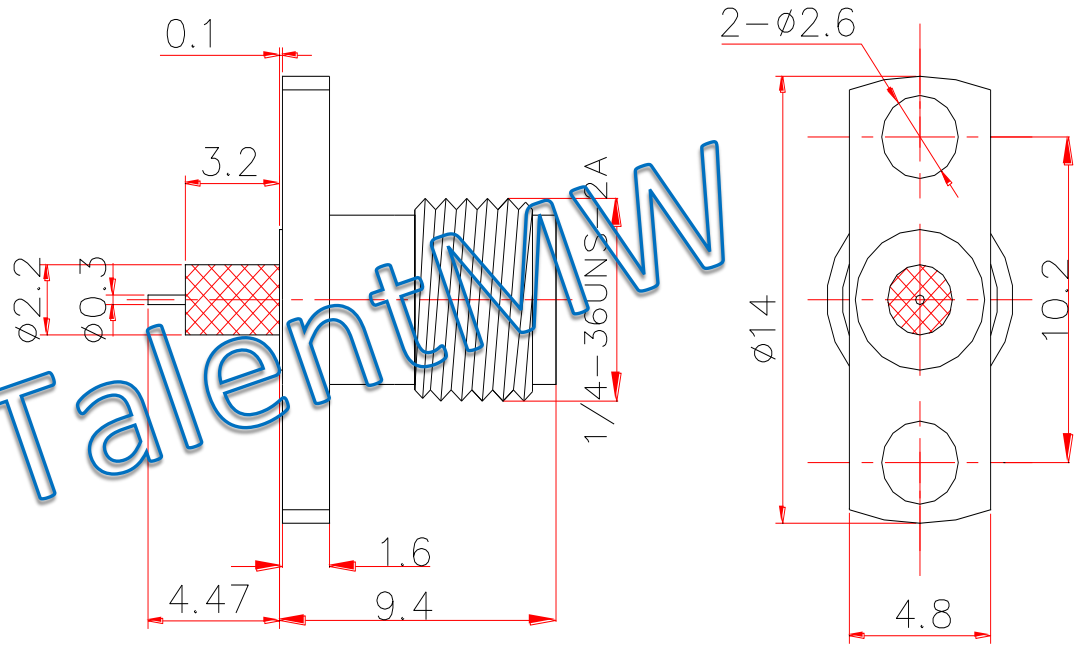

Electrical & Environmental Characteristics

Impedance	50 Ohm
Insulation Resistance	5000 M Ω
Operating Frequency	26.5GHz
Dielectric Withstanding Voltage	1000 V
VSWR	1.15
Insertion Loss	0.05* $\sqrt{f_GHz}$
Operating Temperature	-55~+165 $^{\circ}C$

Material & Coat-Plating

Inner Conductor	Beryllium Copper, Gold
Dielectric	PTFE
Body	Stainless Steel, Passivated
Coupling Nut	N/A

THIS DRAWING IS A CONTROLLED DOCUMENT		DWN	Suzhou Talent Microwave, Inc				
		CHK					
Unit mm	TOLERANCES UNLESS OTHERWISE SPECIFIED 0 PLC ± 0.25 1 PLC ± 0.15 2 PLC ± 0.12 3 PLC \pm 3 PLC \pm ANGLES $\pm 1^{\circ}$	APVD	Product Mode SMA-KFD60501 SMA Female Flange Connector				
		PRODUCT SPEC					
		APPLICATION SPEC					
MATERIAL SEE TABLE	FINISH SEE TABLE	WEIGHT	SIZE A4	GAGE CODE 0T8L4	DRAWING NO		
		CUSTOMER DRAWING		SCALE 4: 1	SCALE 4: 1	SHEET 1 OF 1	RVE 1