

Part No.: RS2W0205-S

Power divider/Combiner 2 Way SMA 50Ω 200 to 500MHz

电气特性 Electrical:

工作频率 Frequency Range: 200-500MHz

插入损耗 Insertion Loss: $\leq 0.4\text{dB}$

驻波 VSWR: 1.25: 1

隔离 Isolation: $\geq 20\text{dB}$

幅度平衡 Amplitude Balance: $\pm 0.2\text{dB}$

相位平衡 Phase Balance: $\pm 2^\circ$

耐功率 Power Handling: 30 Watt

阻抗 Impedance: 50 OHMS

机械特性 Mechanical:

温度范围 Temperature Range: $-45^\circ\text{C} - +85^\circ\text{C}$

接口 Connectors: SMA-Female

相对湿度 Relative Humidity: 0 ~ 90%

外形尺寸 Outline Drawing:

Unit: mm

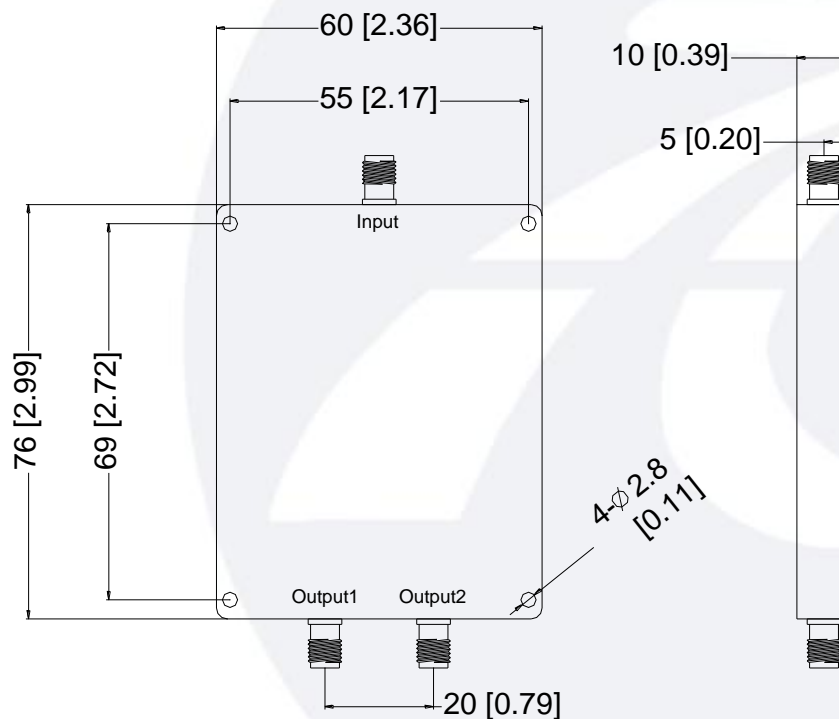

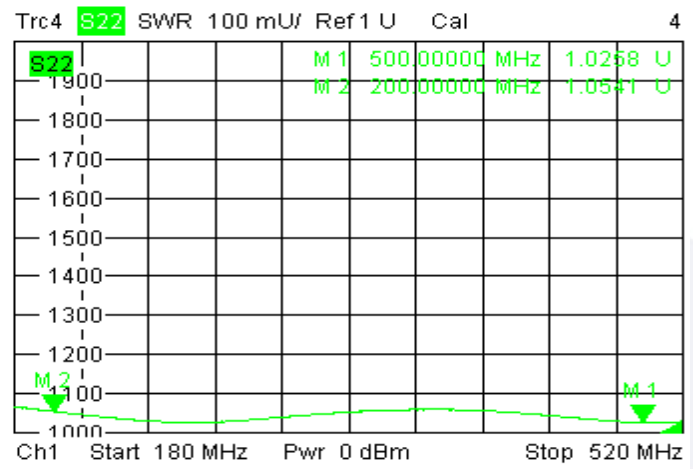
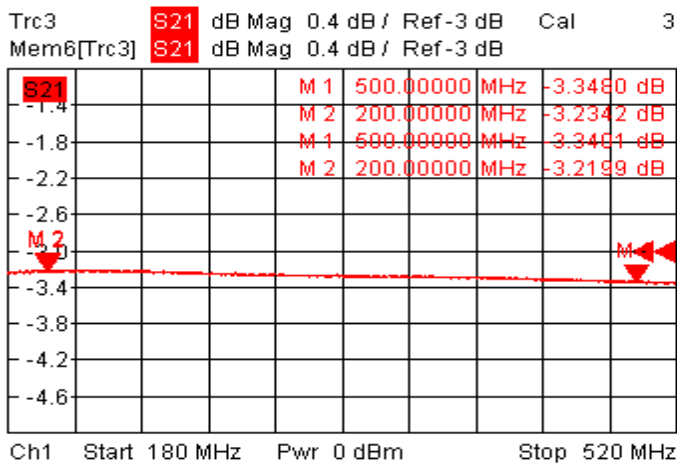
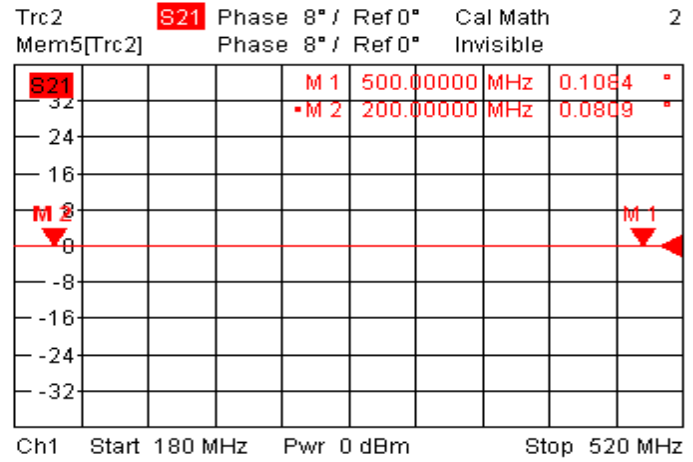
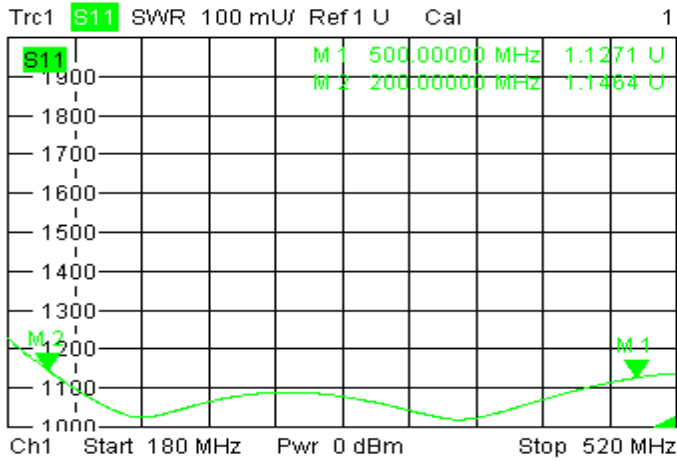

1/11/2019, 10:52 AM

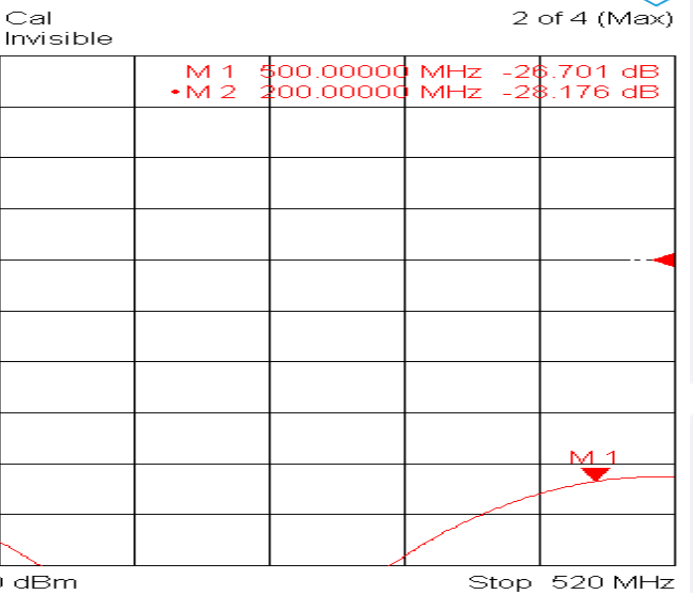
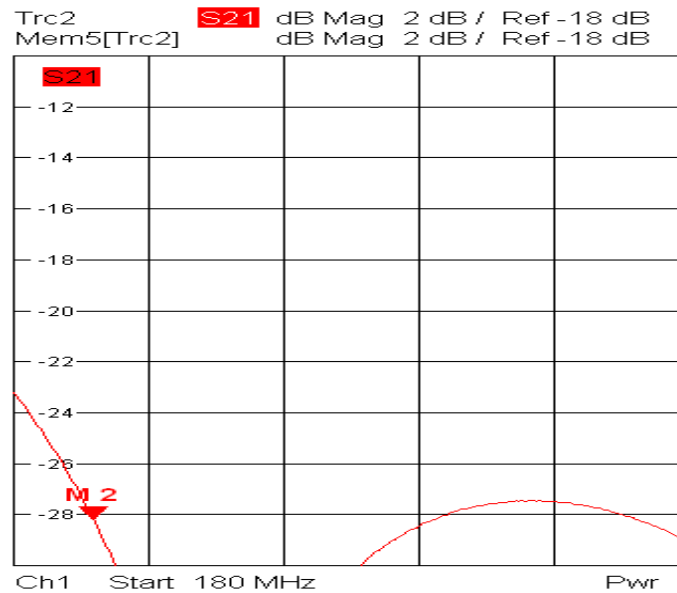

1/11/2019, 10:53 AM