

**Model:TLPA0.4G8G-44-30**

**Power amplifier,0.4-8GHz,Gain:44dB,  
Psat:30 dBm**

**Feature:**

- Ultra Wide Band: 0.4-8GHz
- Gain: 44dB
- Psat Output Power: 30 dBm
- Good Power and Gain Flatness
- 50 Ohm Matched Input / Output

**电气特性 Electrical:**

参数Parameter	Min.	Typ.	Max.	单位Units
频率范围 Frequency range	0.4-8			GHz
增益 Gain		44		dB
增益平坦度 Gain Flatness		±2.0		dB
P1dB	28	29	30	dB
饱和输出功率 Psat	28.5	30		dBm
输入驻波 Input VSWR		2.0	2.5	:1
输出驻波 Output VSWR		1.8	2.4	:1
最大输入功率 max input power			+15	dBm
直流电压 DC Voltage	+13	+15	+16	V DC
直流电流 DC Supply Current	500			mA
阻抗 Impedance	50			Ohms

**机械特性 Mechanical :**

参数Parameter	指标 Value	单位Units
输入输出接Input /Output Connector	SMA Female	
直流偏置 Bias	Solder Pin	
重量 Weight	/	g



**绝对最大值 Absolute Maximum Ratings:**

参数Parameter	指标 Value
供电偏置电压 Supply Bias Voltage	TBD
输入功率 RF INPUT POWER	+15 dBm
ESD灵敏度 ESD sensitivity (HBm)	Class 0, passed 150V

外形尺寸 Outline Drawing:

Unit: mm(inches)

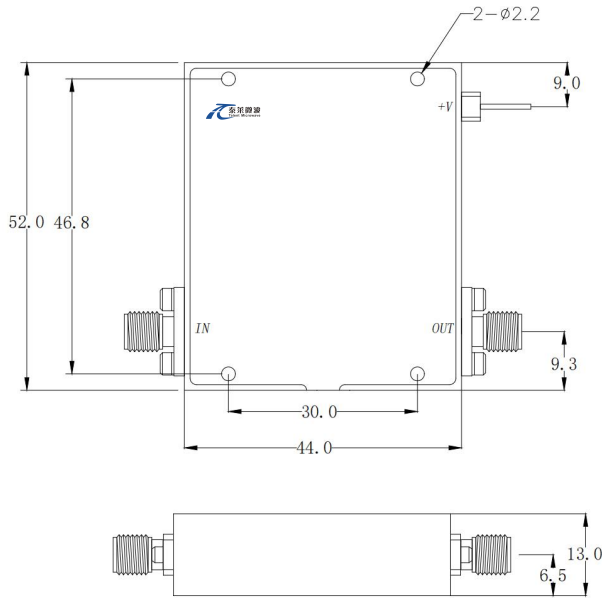

温度环境 Environmental Conditions:

参数Parameter	Min.	Typ.	Max.	单位Units
操作温度 Operating Temperature	-45		+85	°C
存储温度 Non-operating Temperature	-55		+125	°C
相对湿度 Relative humidity		95		%
海拔 Altitude	30,000			feet
震动 Shock / Vibration(MIL-STD-810F)	20g,11ms,saw-tooth			
冲击 Shock(non operating)	20G for 11msc half sin wave,3 axis both directions			

订货信息 Ordering Information:

标准型号 Part Number	描述 Description	版本号Revision
TLPA0.4G8G-44-30	Power amplifier 0.4-8GHz,Gain:44dB,Psat:30dBm,15V DC,SMA-Female	Rev.1.1

典型曲线 Typical Performance Data:

### Gain & VSWR vs Frequency

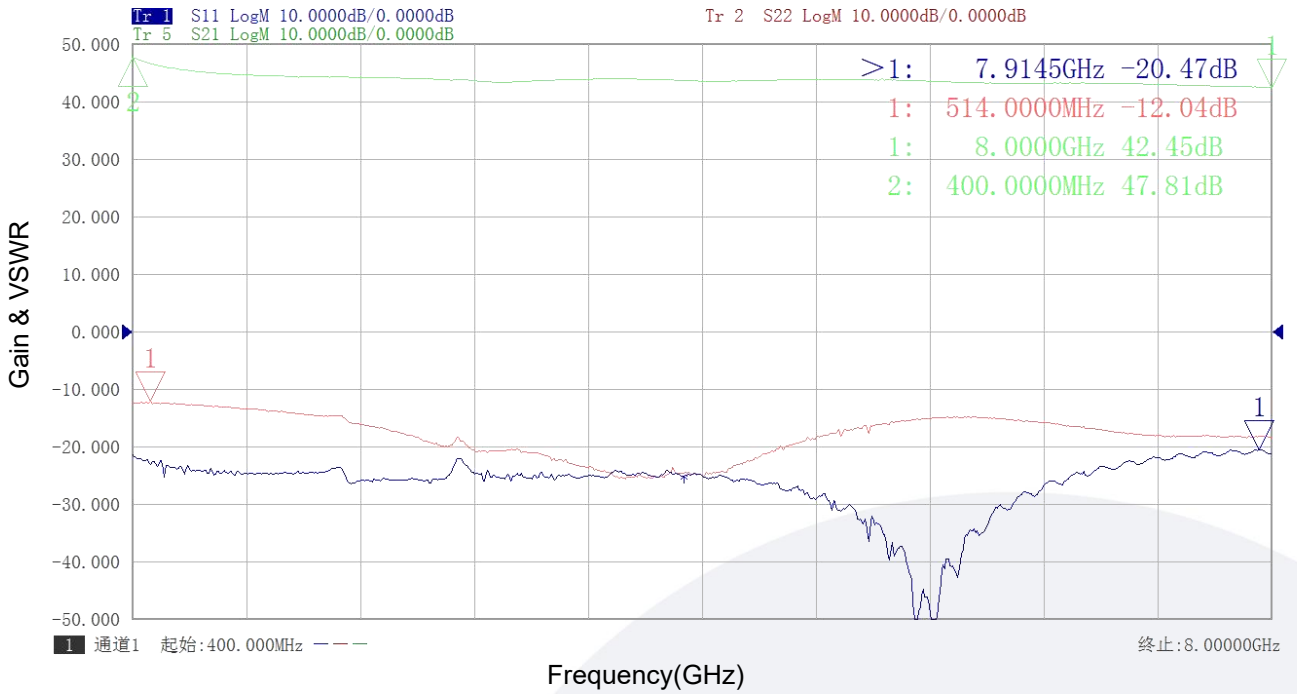

### Gain vs Output Power

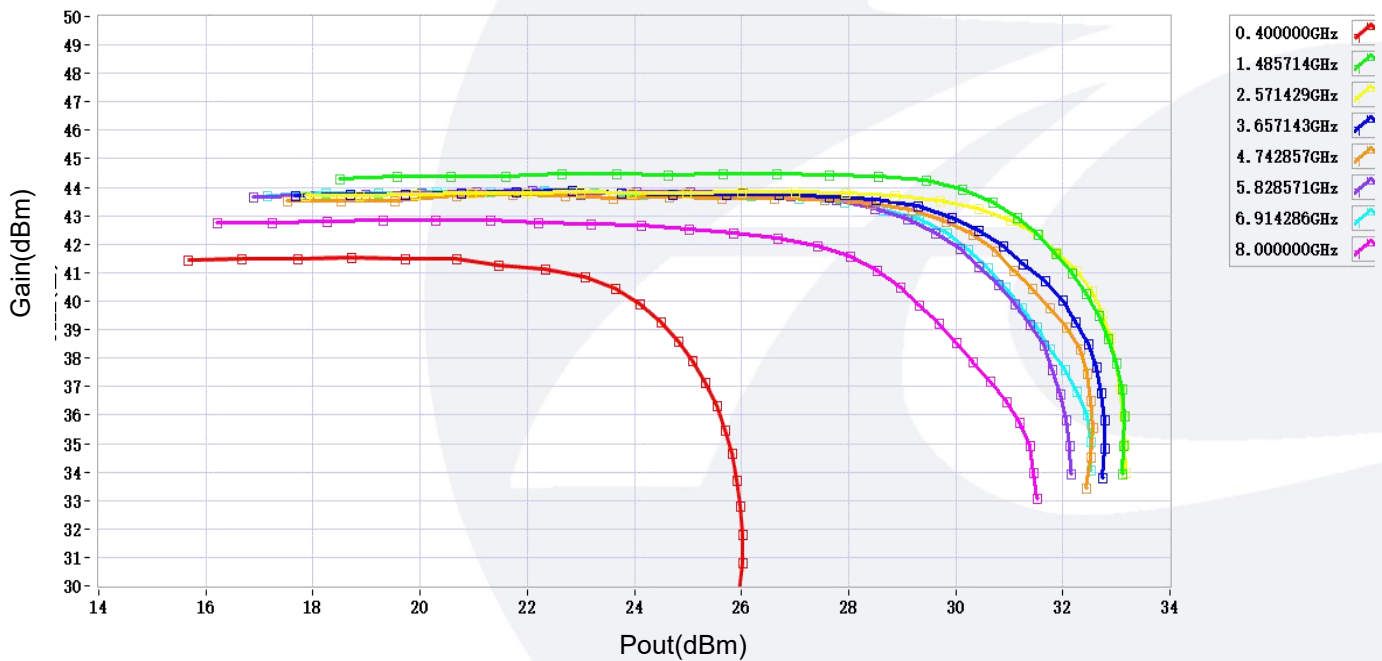

典型曲线 Typical Performance Data:

P1dB vs Frequency

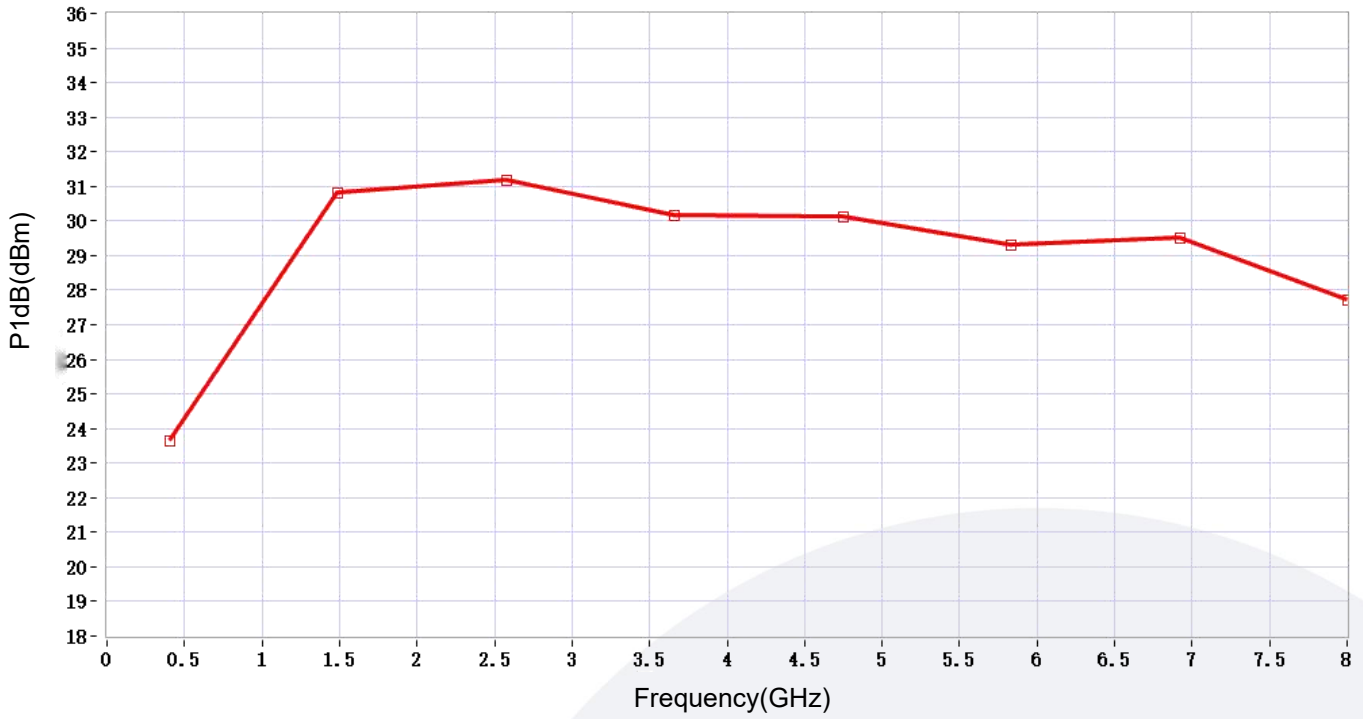

PSat vs Frequency

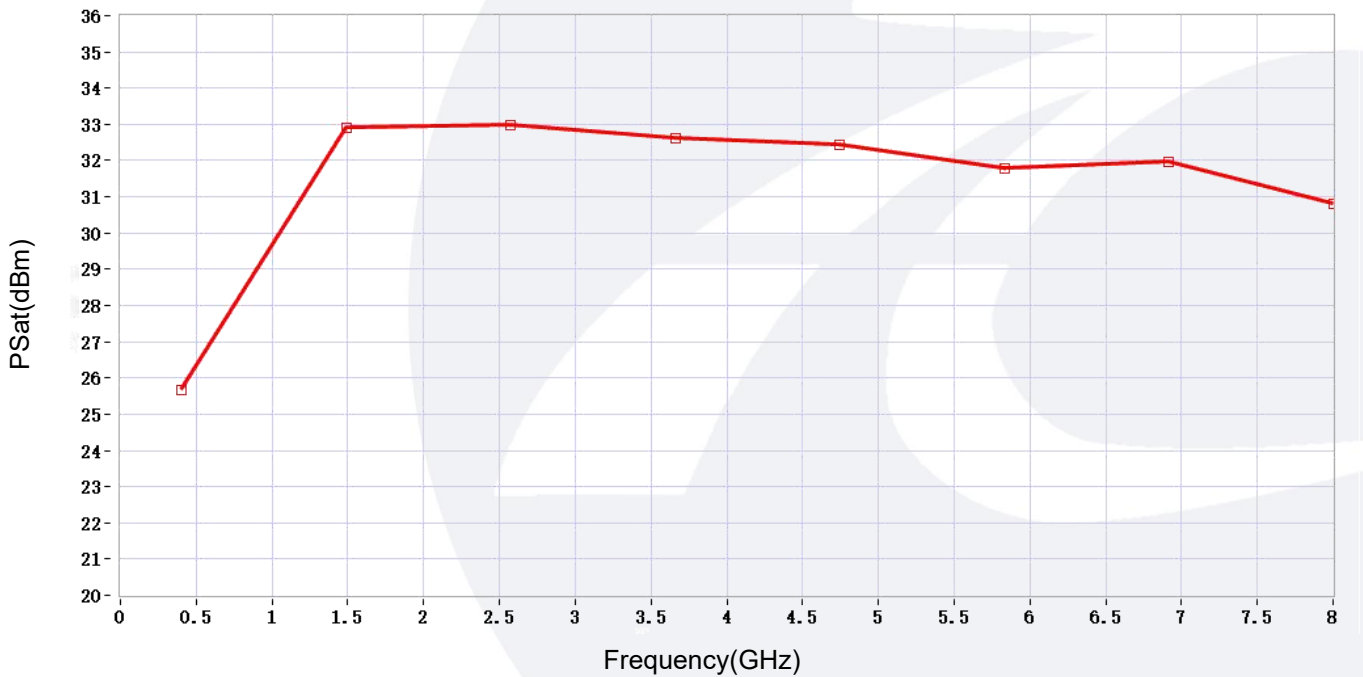

典型曲线 Typical Performance Data:

### 2nd Harmonic (dBc) vs Output Power

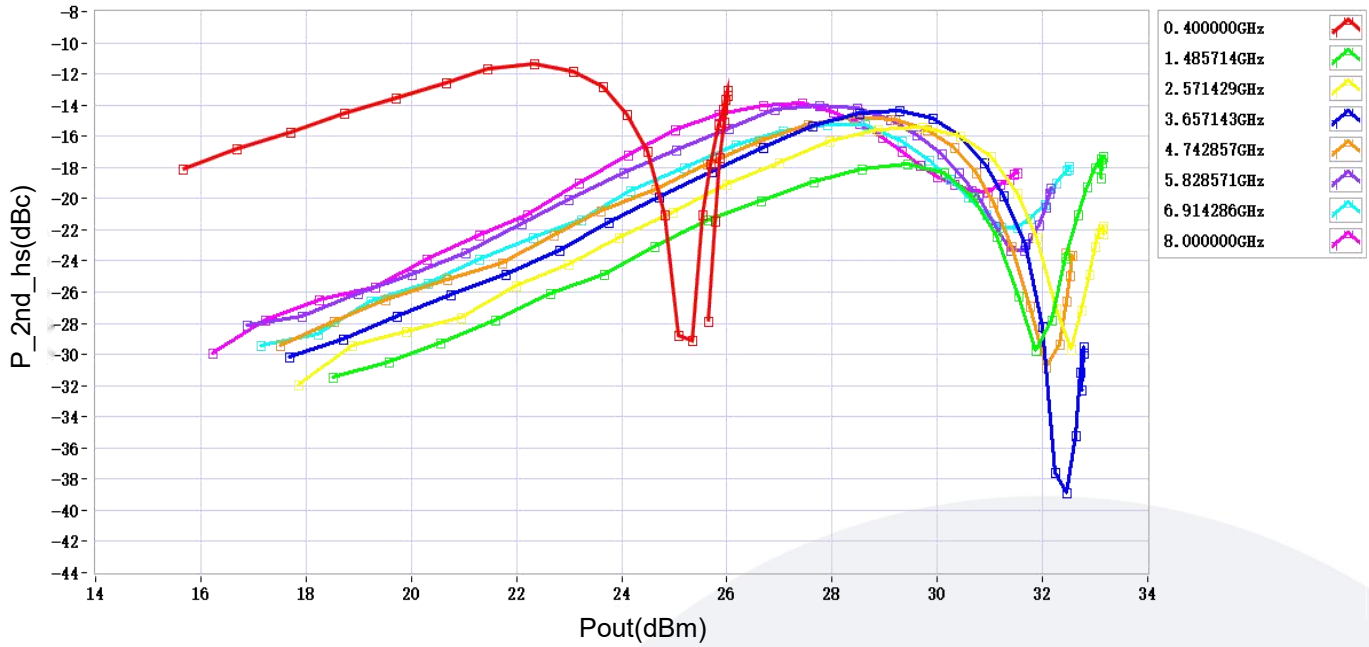

### 3rd Harmonic (dBc) vs Output Power

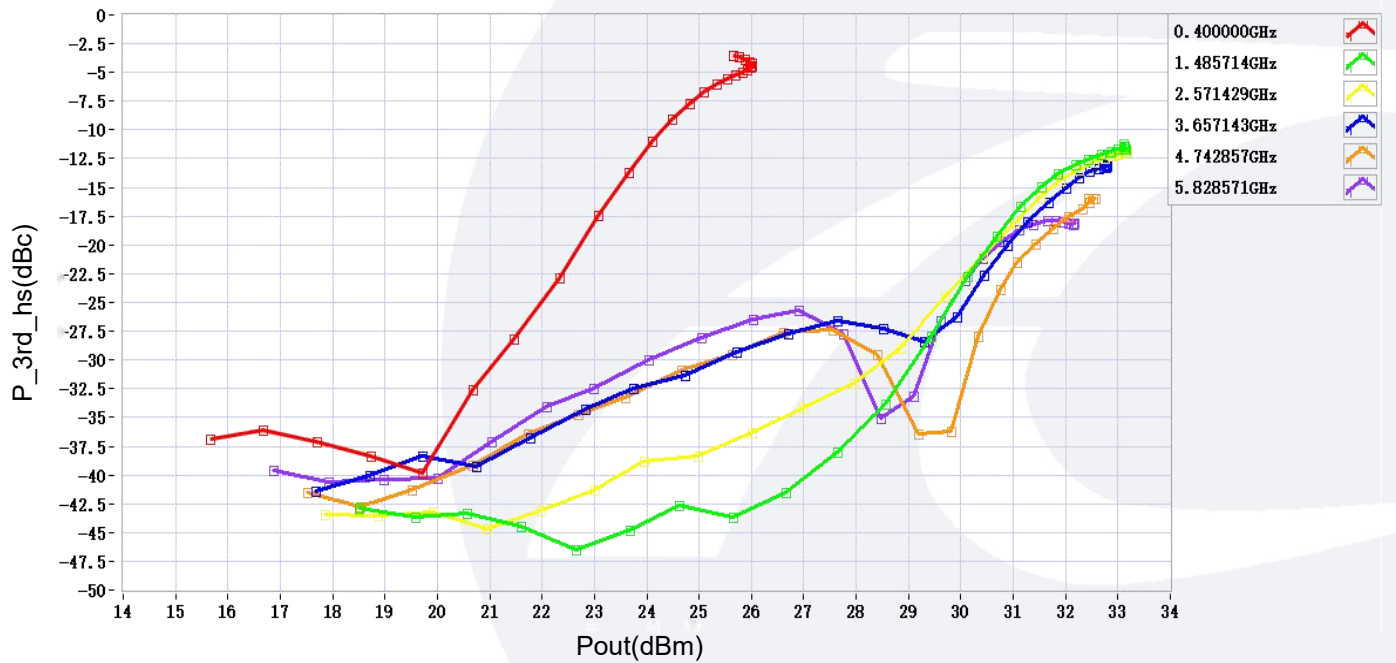

典型曲线 Typical Performance Data:

Current vs Output Power

