

Model:TL-10200DR10S

Broadband Horn Antenna 1-20GHz, Gain:10 dB,Typ

Feature:

- Ultra Wide Band: 1-20 GHz
- Gain: 10dB Typ
- Ideal for Antenna Measurements
- Broadband Operation,Linear Polarization,Small Size

Electrical Specifications:

Parameter	Min	Typ	Max	Units
Frequency range	1-20			GHz
Gain	7	10	16	dB
Input VSWR				:1
AF	35			dB/m

Mechanical Specifications:

Parameter	Value	Units
Connector	SMA Female	
Material	Al	
Size	243*205.7*163.5	mm

Outline Drawing:

Unit: mm(inches)

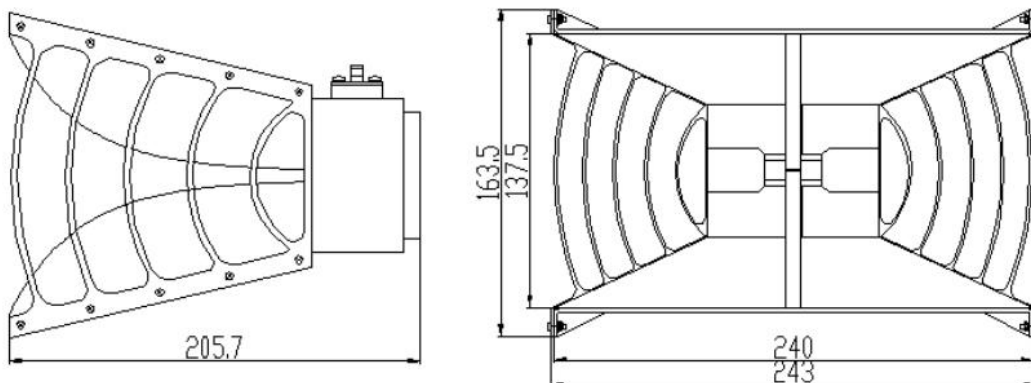

Ordering Information:

Part Number	Description	Revision
TL-10200DR10S	Broadband Horn Antenna, 1-20GHz,Gain: 10 dBm Typ.	Rev.1.1

Typical Performance Data:

VSWR vs Frequency

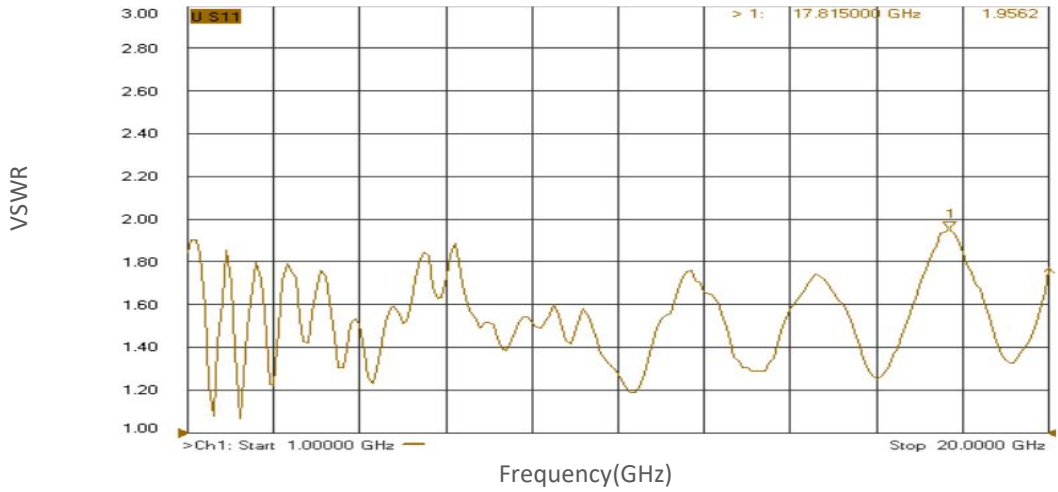

Gain vs Frequency

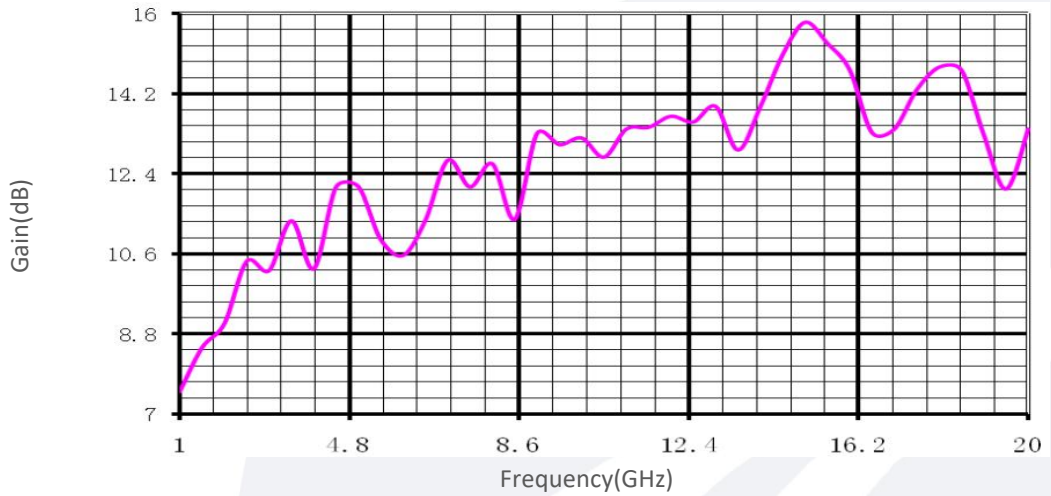

Pattern

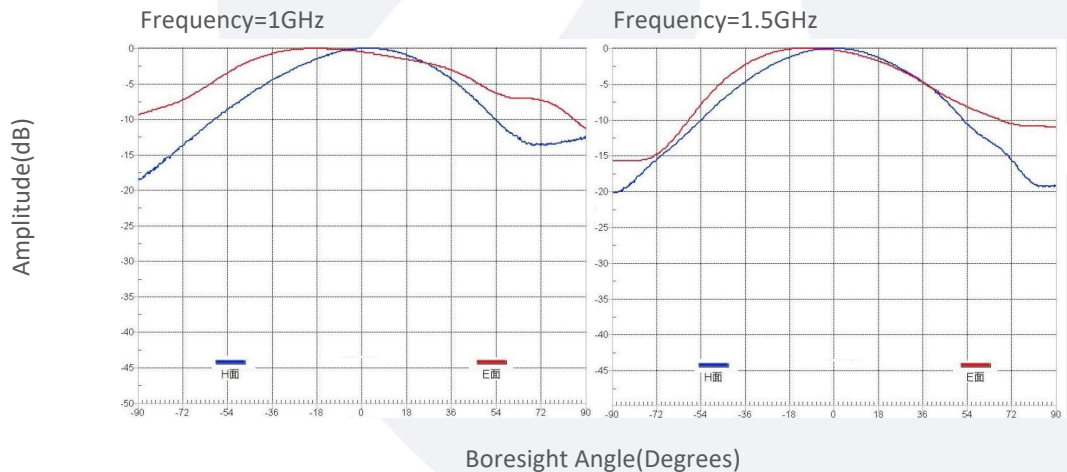

Typical Performance Data:

Pattern

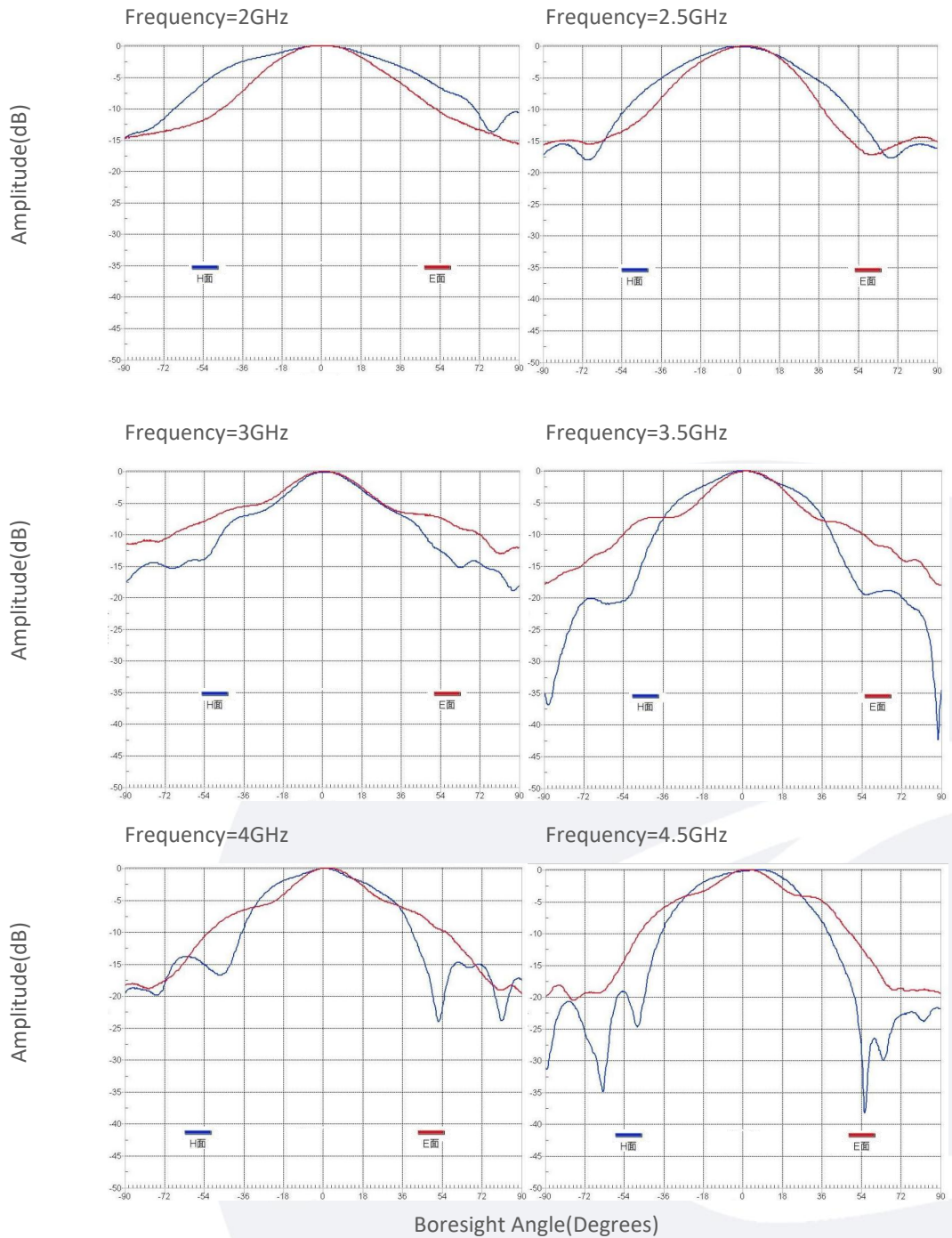

Typical Performance Data:

Pattern

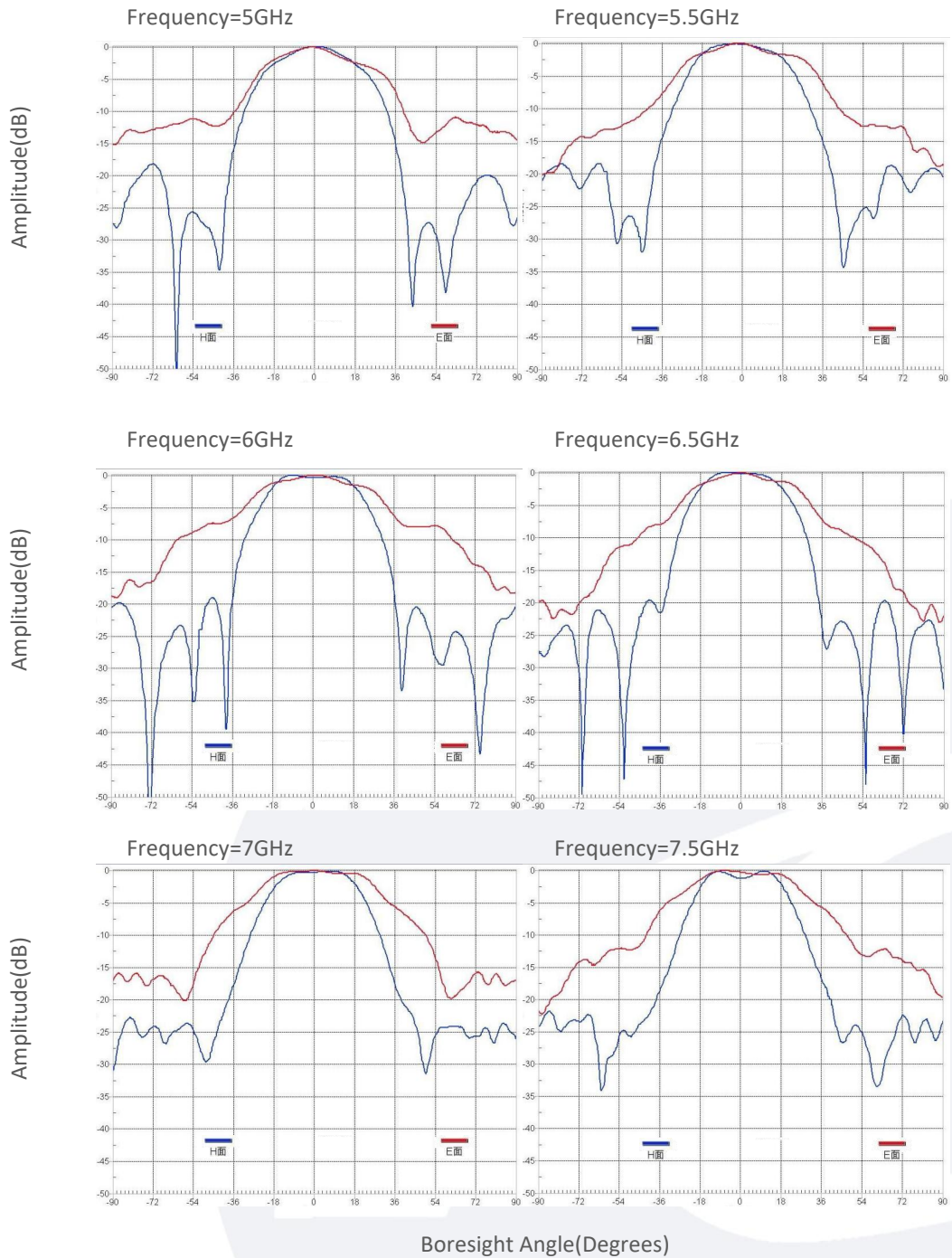

Typical Performance Data:

Pattern

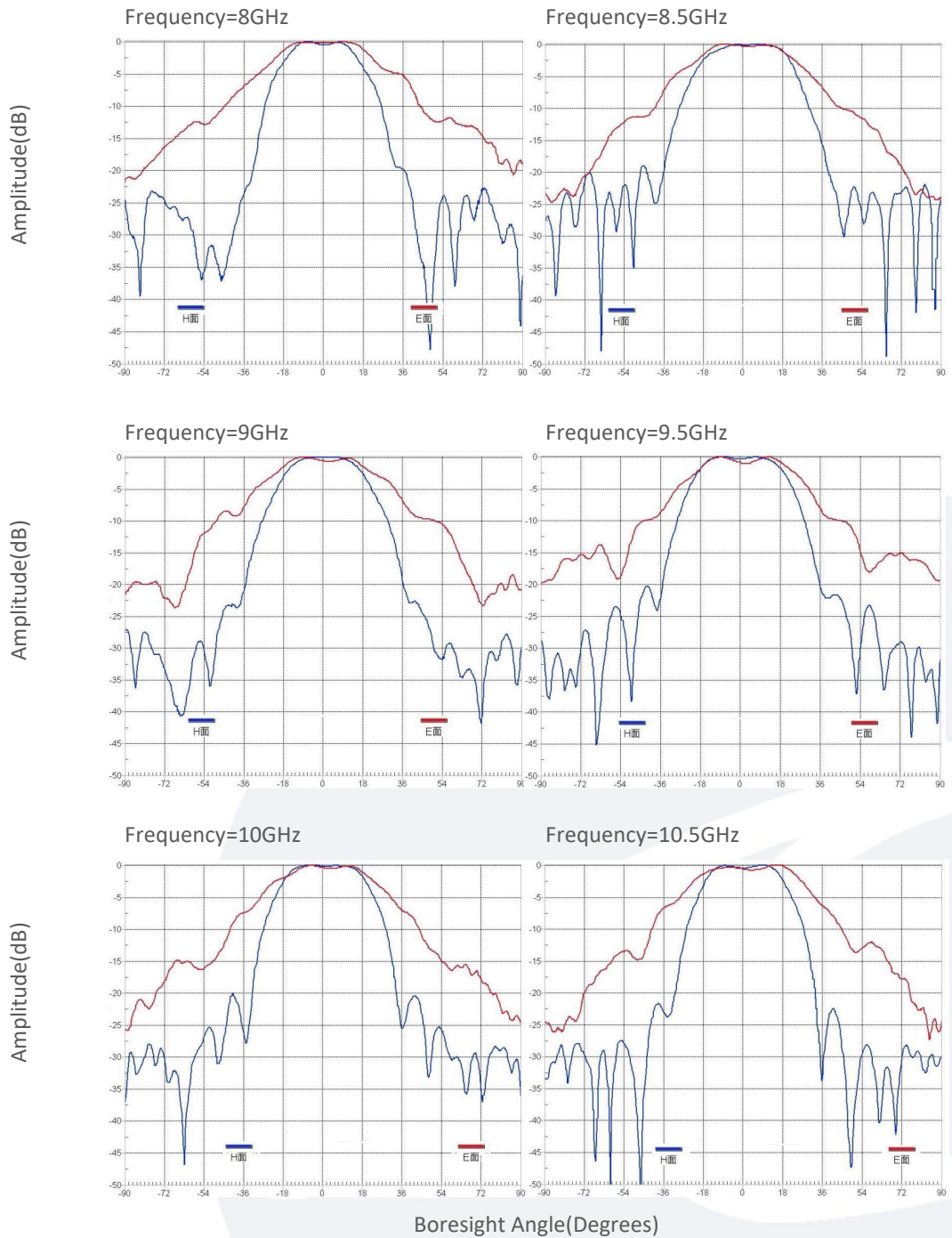

Typical Performance Data:

Pattern

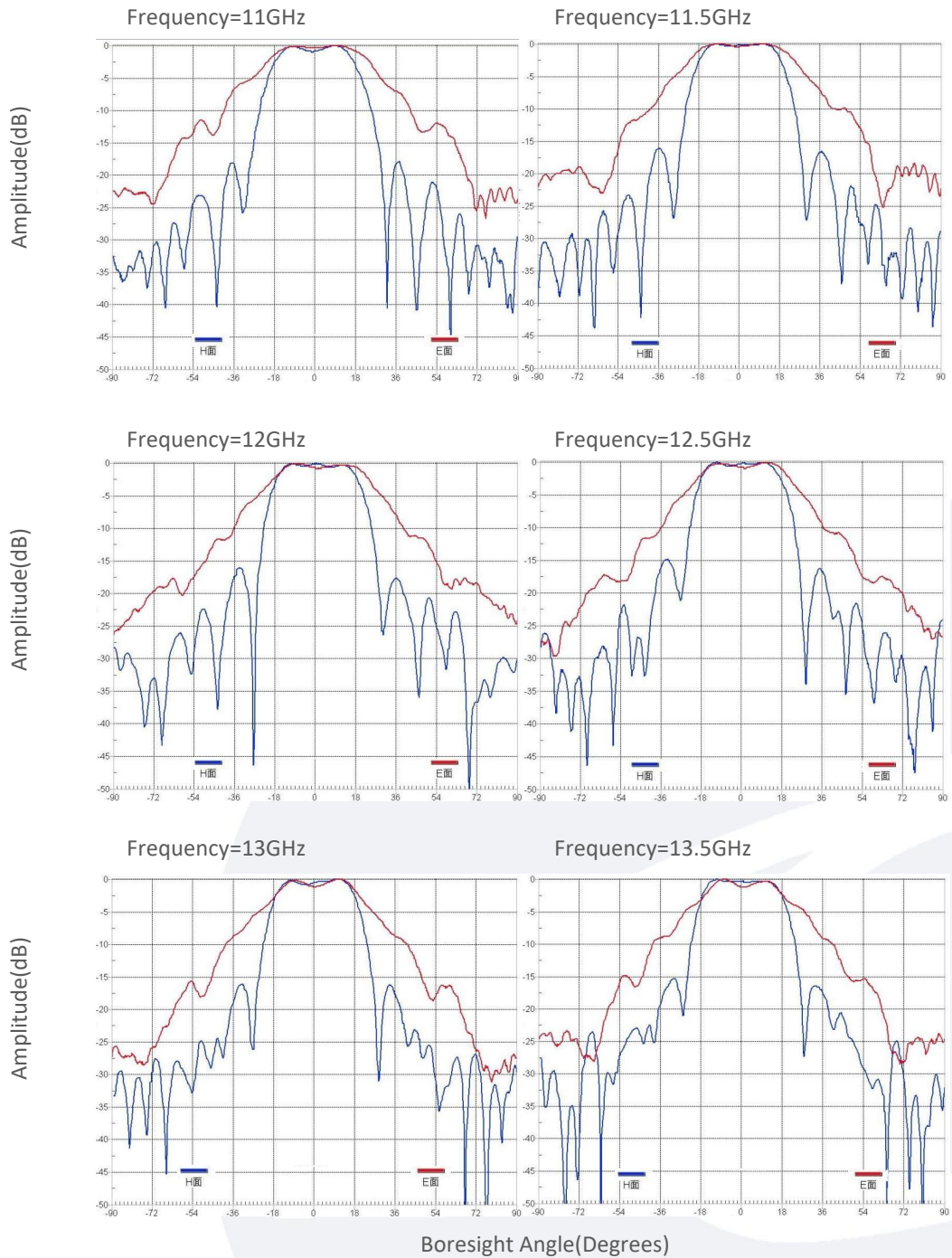

Typical Performance Data:

Pattern

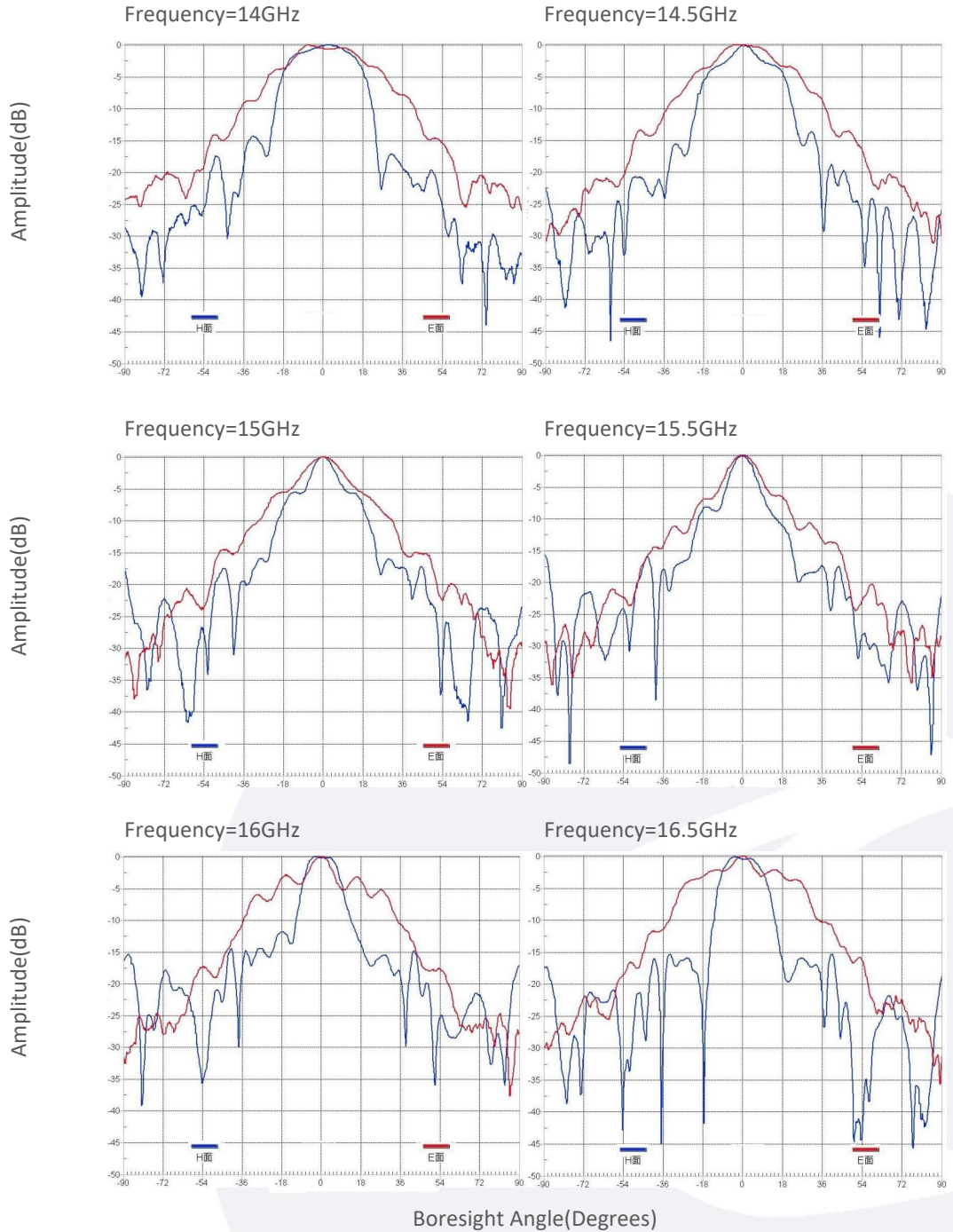

Typical Performance Data:

Pattern

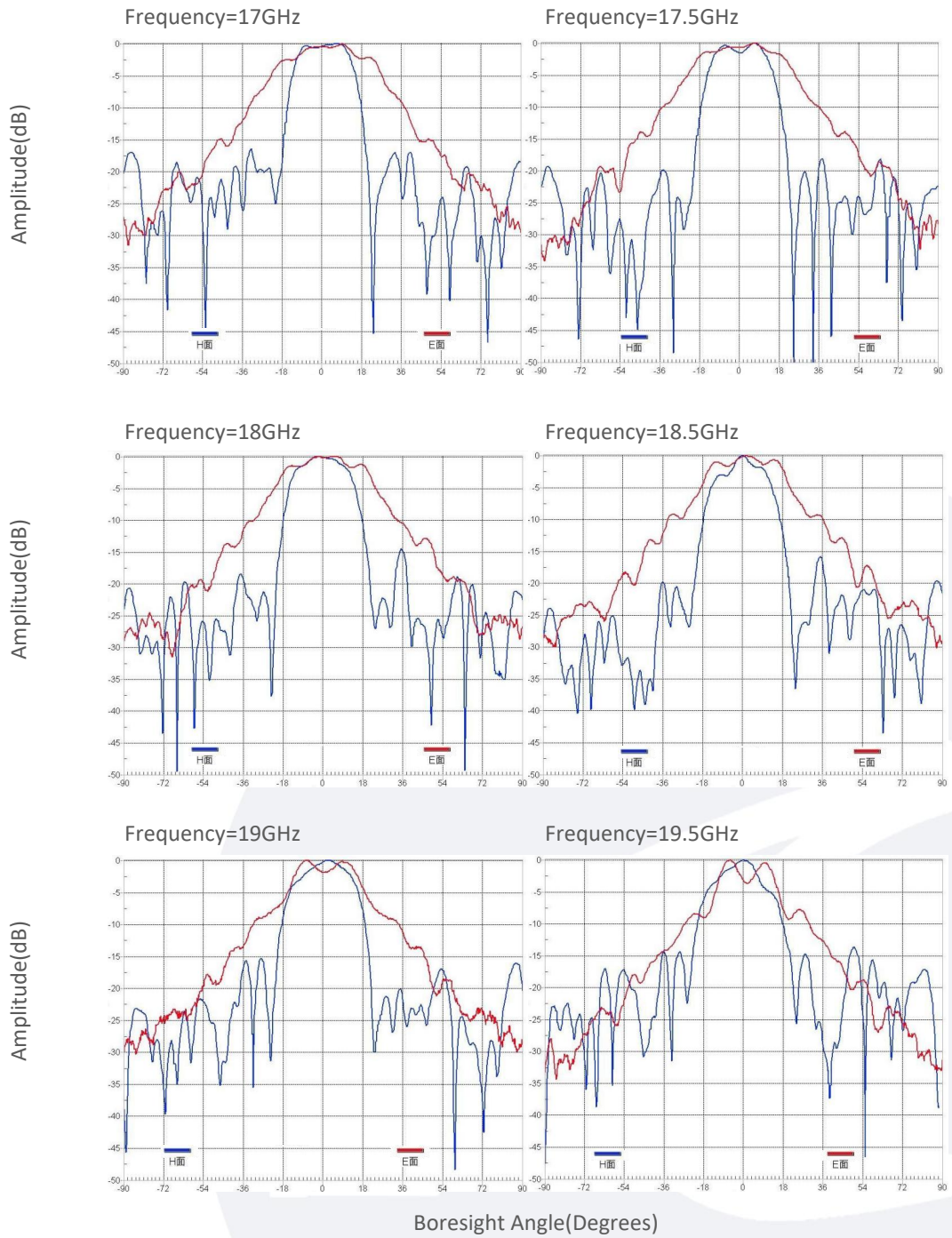

Typical Performance Data:

Pattern

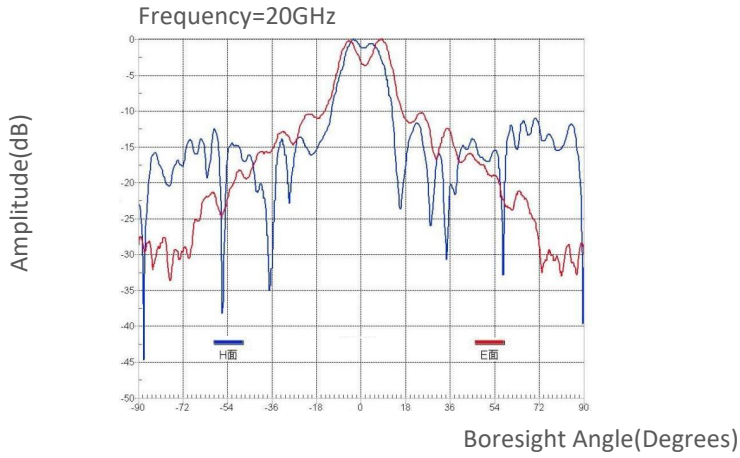

AF vs Frequency

