

DETAIL B(20:1)

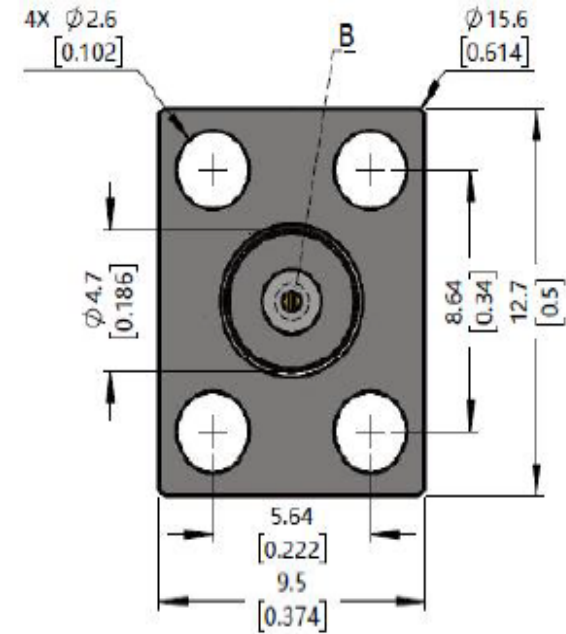

Electrical & Environmental Characteristics	
Impedance	50 Ω
Insulation Resistance	5000 MΩ
Operating Frequency	DC~26.5GHz
Dielectric Withstanding Voltage	1000V
VSWR	≤1.15
Insertion Loss	≤0.05* $\sqrt{f\_GHz}$
Operating Temperature	- 55~+165℃
Material & Coat-Plating	
Inner Conductor	Beryllium Copper, Gold
Dielectric	PTFE
Body	Stainless Steel, Passivated
Coupling Nut	N/A

No.	Model	D(Diameter)	L(Length)	T(Thickness)
1	SMA-KFD40311	0.64 [0.025]	4 [0.157]	0.2 [0.008]
2	SMA-KFD40311-04	0.64 [0.025]	1 [0.039]	0.2 [0.008]
3	SMA-KFD40311-787	0.64 [0.025]	2 [0.079]	0.2 [0.008]
4	SMA-KFD40311-2M	0.64 [0.025]	6 [0.236]	0.2 [0.008]

THIS DRAWING IS A CONTROLLED DOCUMENT		DWN	Suzhou Talent Microwave, Inc		
		CHK			
Unit mm	TOLERANCES UNLESS OTHERWISE SPECIFIED 0 PLC ±0.25 1 PLC ±0.15 2 PLC ±0.12 3 PLC ± 3 PLC ± ANGLES ±1°	APVD	Product Model  SMA-KFD40311-04 SMA Female Flange Connector		
MATEIAL SEE TABLE	FINISH SEE TABLE	PRODUCT SPEC	APPLICATON SPEC	SIZE A4	GAGE CODE 0T8L4
		WEIGHT	DRAWING NO		
		CUSTOMER DRAWING	SHEET1 OF 1		RVE 1