

Spectrum Frequency Extension Systems

260-400GHz/WR-2.8

Model: TLSM-260400-24-2.8

TLSM-260400-24-2.8 spectrum frequency extension systems are a dedicated Test & Measurement solution for extending the range of your signal source to 260-400 GHz.

Features:

- Frequency range: 260-400 GHz
- Conversion Loss SSB: 15dB Typ
- Low conversion loss

Applications:

- Frequency Extension
- Antenna measurements
- Material characterisation

电气特性 Electrical Characteristics:

参数 Parameter	Min	Typ	Max	单位 Units
频率范围 Frequency range	260		400	GHz
中频输出频率 IF Output Frequency	DC		5	GHz
本振输入频率 LO Input Frequency	10.83		16.67	GHz
本振输入功率 LO Input Power	13	15	20	dBm
倍频次数 Multiplication Factor	24			
射频输入功率 RF Input Power		-10	0	dBm
变频损耗 Mixer Conversion Loss SSB		15		dB

机械特性 Mechanical Specifications:

描述 Description	参数 Parameter	单位 Units
射频输入端口 RF Input Ports	WR-2.8/UG-387/U	
本振/中频端口 LO/IF Ports	SMA Female	
本振输入端口 LO Input Ports	SMA Female	
中频输出端口 IF Output Ports	SMA Female	
供电引脚 Power Supply Pin	FGG 0B 4 Core	
尺寸 Size	155.2*75.2*52	mm

绝对最大值 Absolute Maximum Ratings :

参数 Parameter	指标 Value
供电电压 Supply Bias Voltage	+240 V AC
射频输入功率 RF Input Power	0 dBm
ESD灵敏度 ESD sensitivity (HBm)	Class 0, passed 150V

外形图 Outline Drawing:

Unit:mm

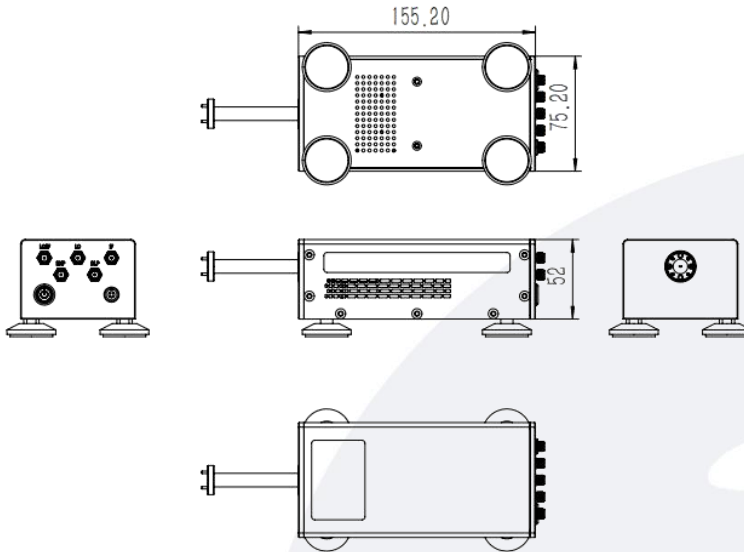

原理框图 Block Diagrams:

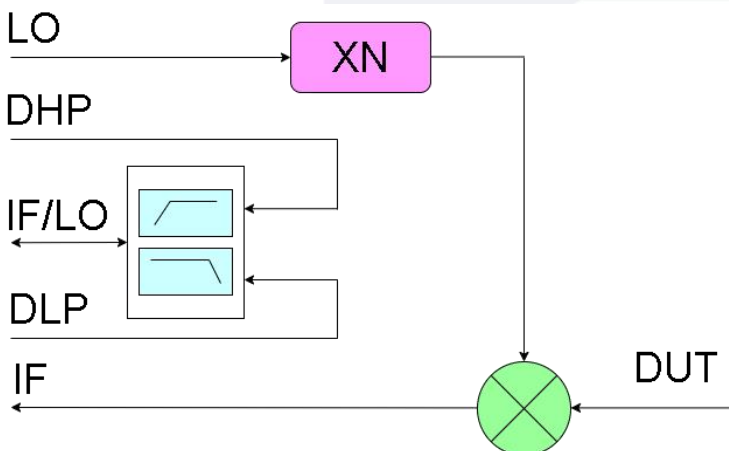

环境和物理特性 Environmental And Physical Characteristics:

参数 Parameter	Min	Typ	Max	单位 Units
操作温度 Operating Temperature	-10		+65	°C
存储温度 Non-operating Temperature	-45		+85	°C
相对湿度 Relative humidity		95		%
海拔 Altitude	10,000			feet
震动 Shock / Vibration(MIL-STD-810F)	25g rms (15 degree 2KHz) endurance, 1 hour per axis			
冲击 Shock(non operating)	20G for 11msc half sin wave,3 axis both directions			

订货信息 Ordering Information:

标准型号 Part Number	描述 Description	版本号 Revision
TLSM-260400-24-2.8	Spectrum Frequency Extension Systems X24,260-400GHz, Conversion Loss SSB: 15dB typ.	Rev.1.0

随货配件 Components Included:

标准型号 Part Number	描述 Description	数量 Quantity
TACTDC-22012	AC-to-DC Power Adapter	1 PCS