

Model:TL-10200DR10S

Broadband Horn Antenna 1-20GHz, Gain:10 dB,Typ

Feature:

- Ultra Wide Band: 1-20 GHz
- Gain: 10dB Typ
- Ideal for Antenna Measurements
- Broadband Operation,Linear Polarization,Small Size

电气特性 Electrical Specifications:

参数 Parameter	Min	Typ	Max	单位 Units
频率范围 Frequency range		1-20		GHz
增益 Gain	7	10	16	dB
驻波 Input VSWR			2	:1
天线系数 AF		35		dB/m

机械特性 Mechanical Specifications:

参数 Parameter	指标 Value	单位 Units
接口 Connector	SMA Female	
材质 Material	Al	
尺寸 Size	243*205.7*163.5	mm

外形尺寸 Outline Drawing:

Unit: mm(inches)

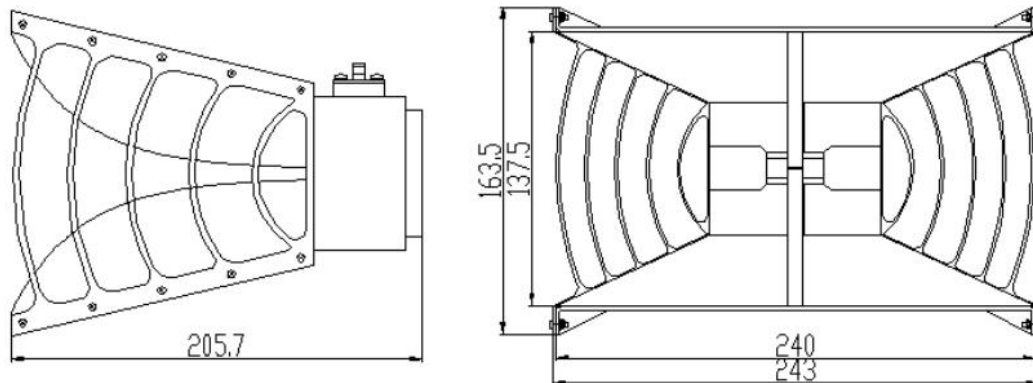

订货信息 Ordering Information:

标准型号 Part Number	描述 Description	版本号 Revision
TL-10200DR10S	Broadband Horn Antenna, 1-20GHz, Gain: 10 dBm Typ.	Rev.1.1

典型曲线 Typical Performance Data:

VSWR vs Frequency

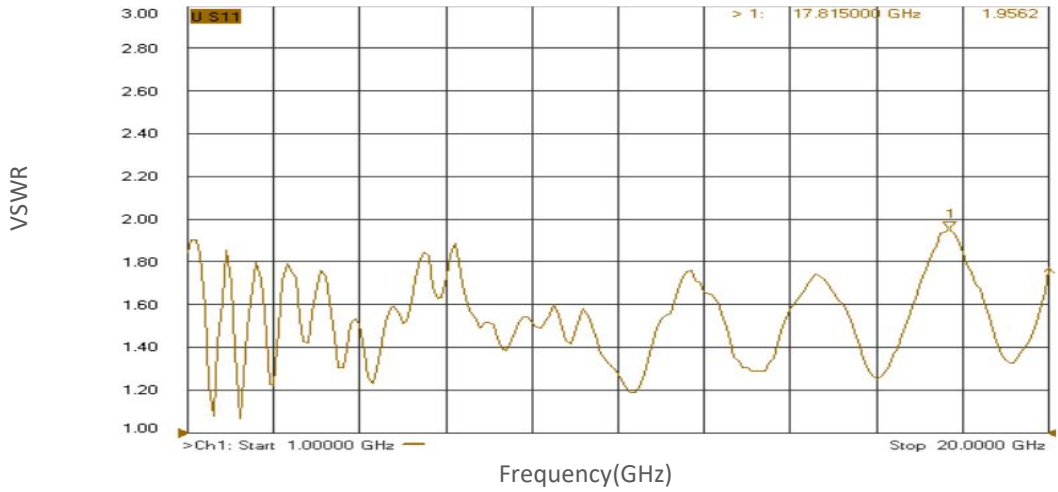

Gain vs Frequency

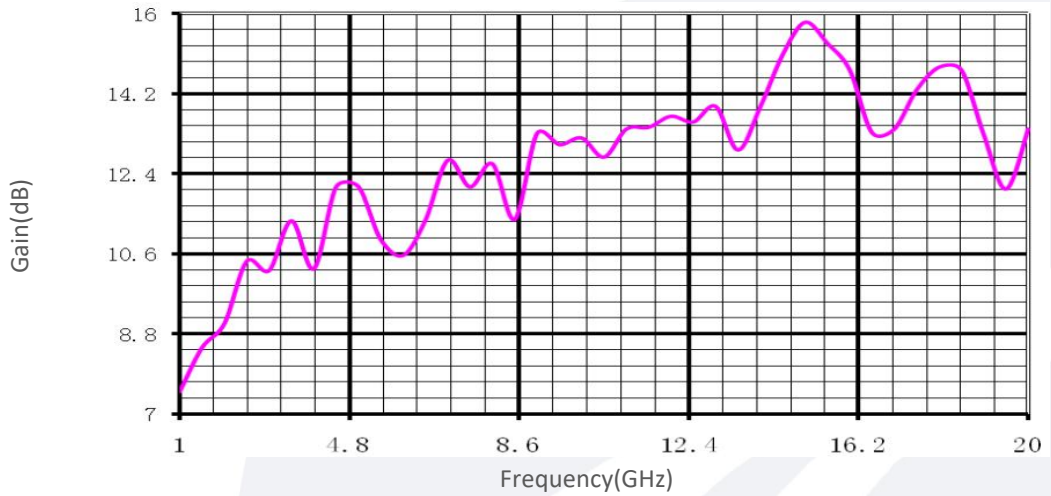

Pattern

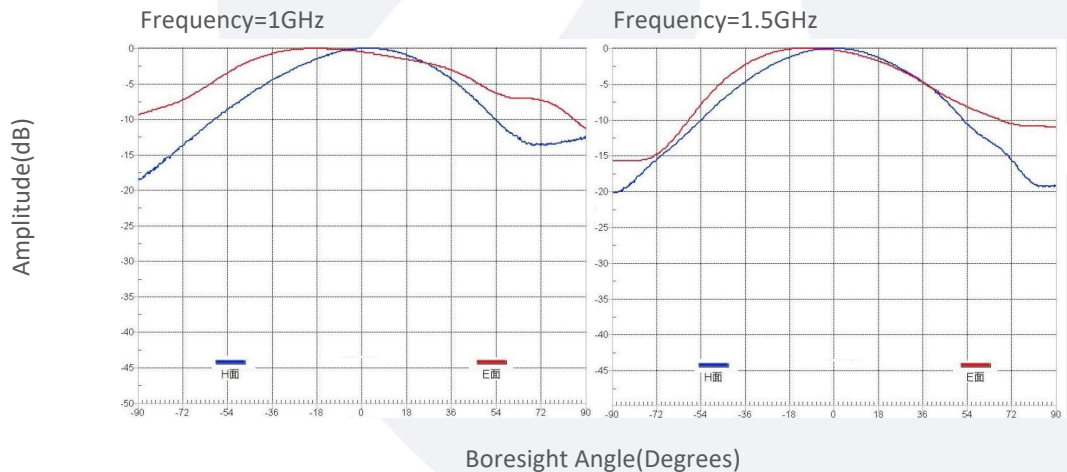

典型曲线 Typical Performance Data:

Pattern

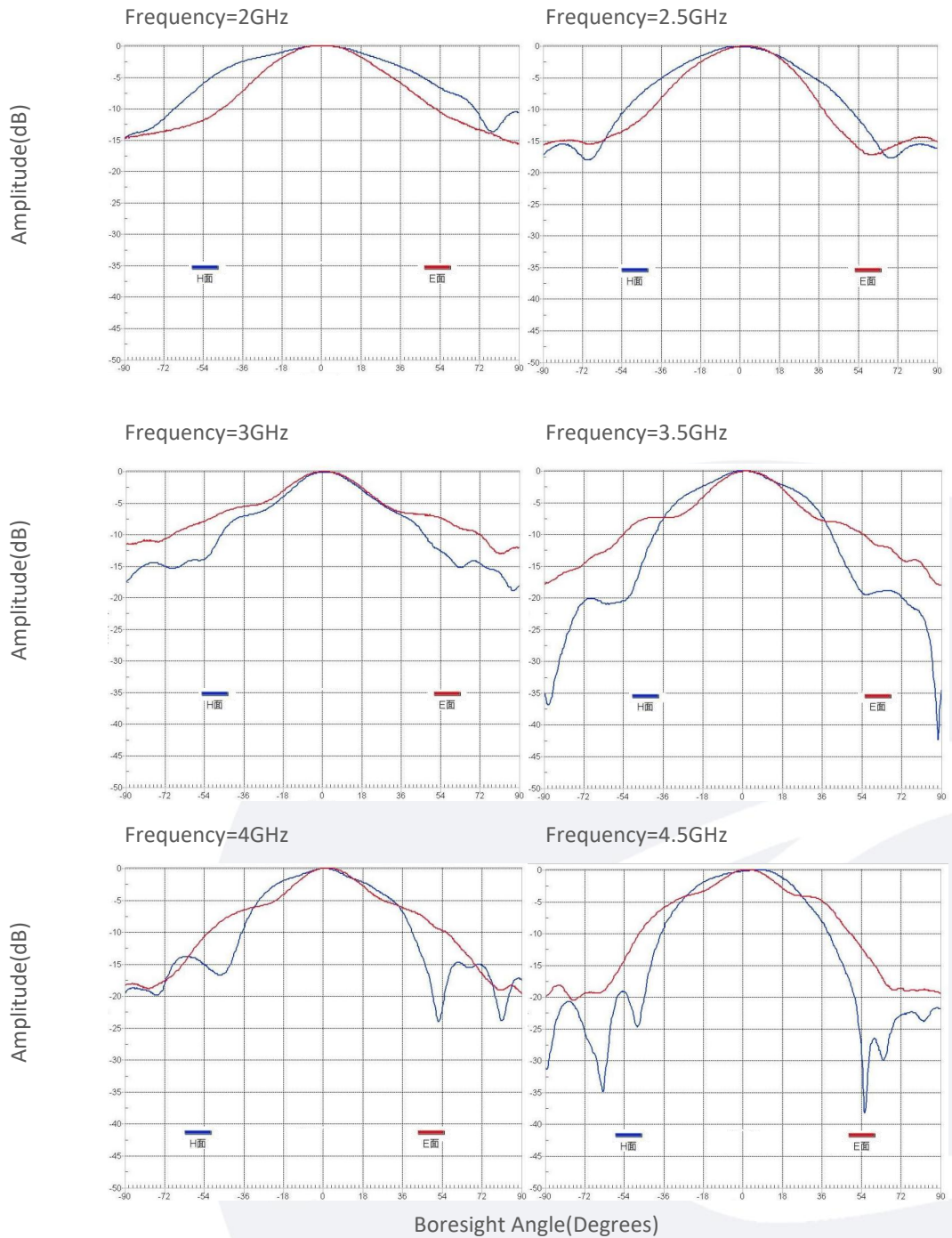

典型曲线 Typical Performance Data:

Pattern

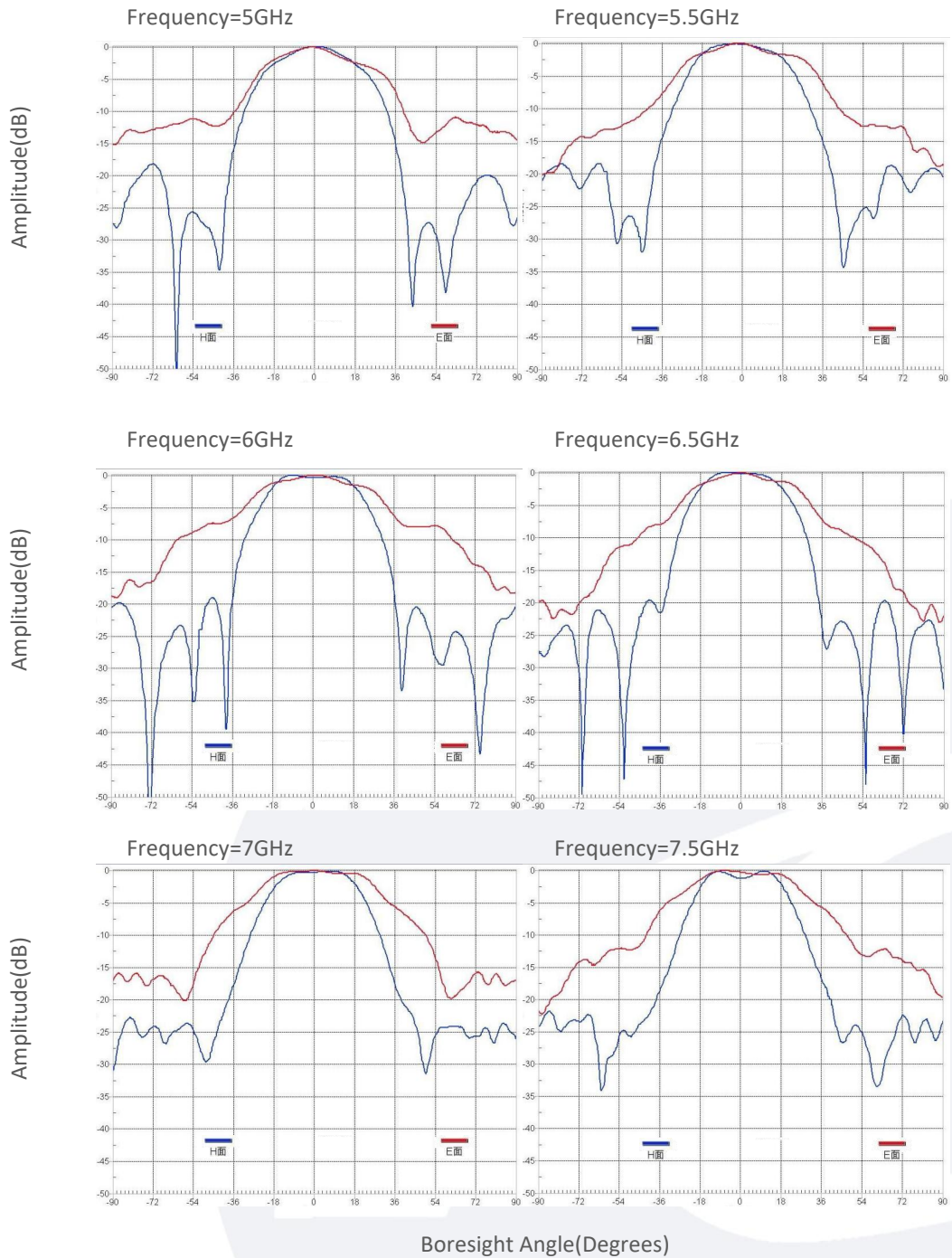

典型曲线 Typical Performance Data:

Pattern

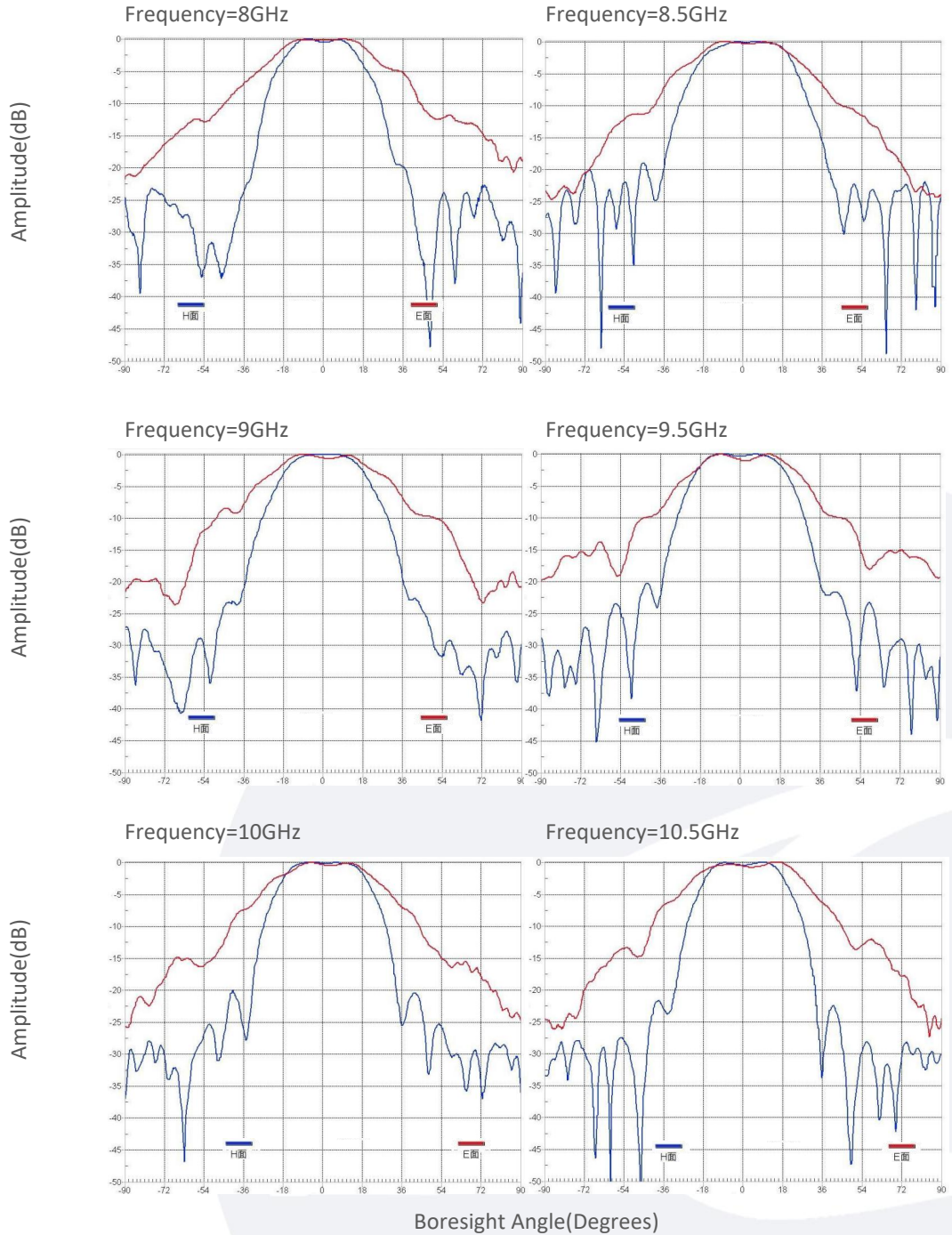

典型曲线 Typical Performance Data:

Pattern

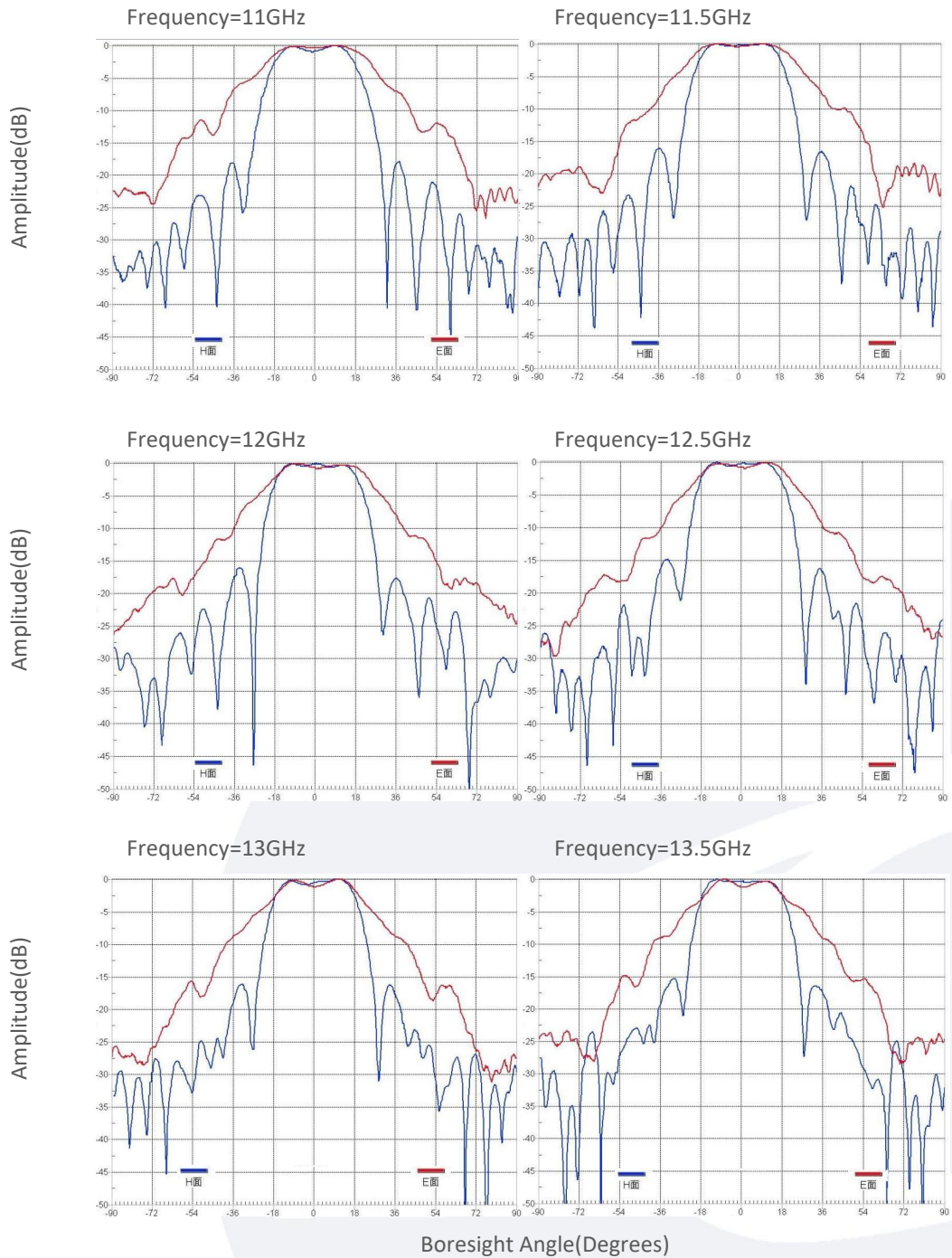

典型曲线 Typical Performance Data:

Pattern

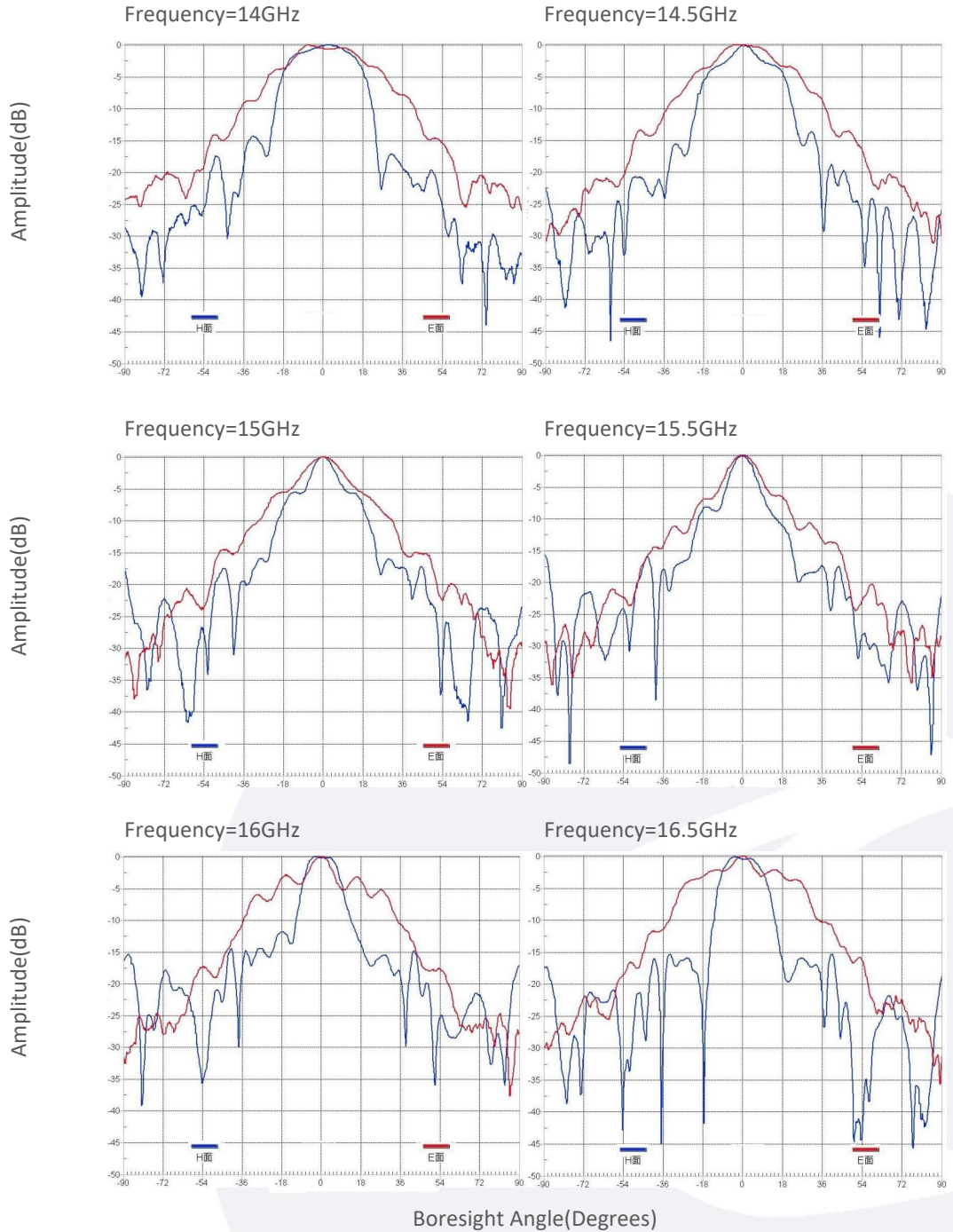

典型曲线 Typical Performance Data:

Pattern

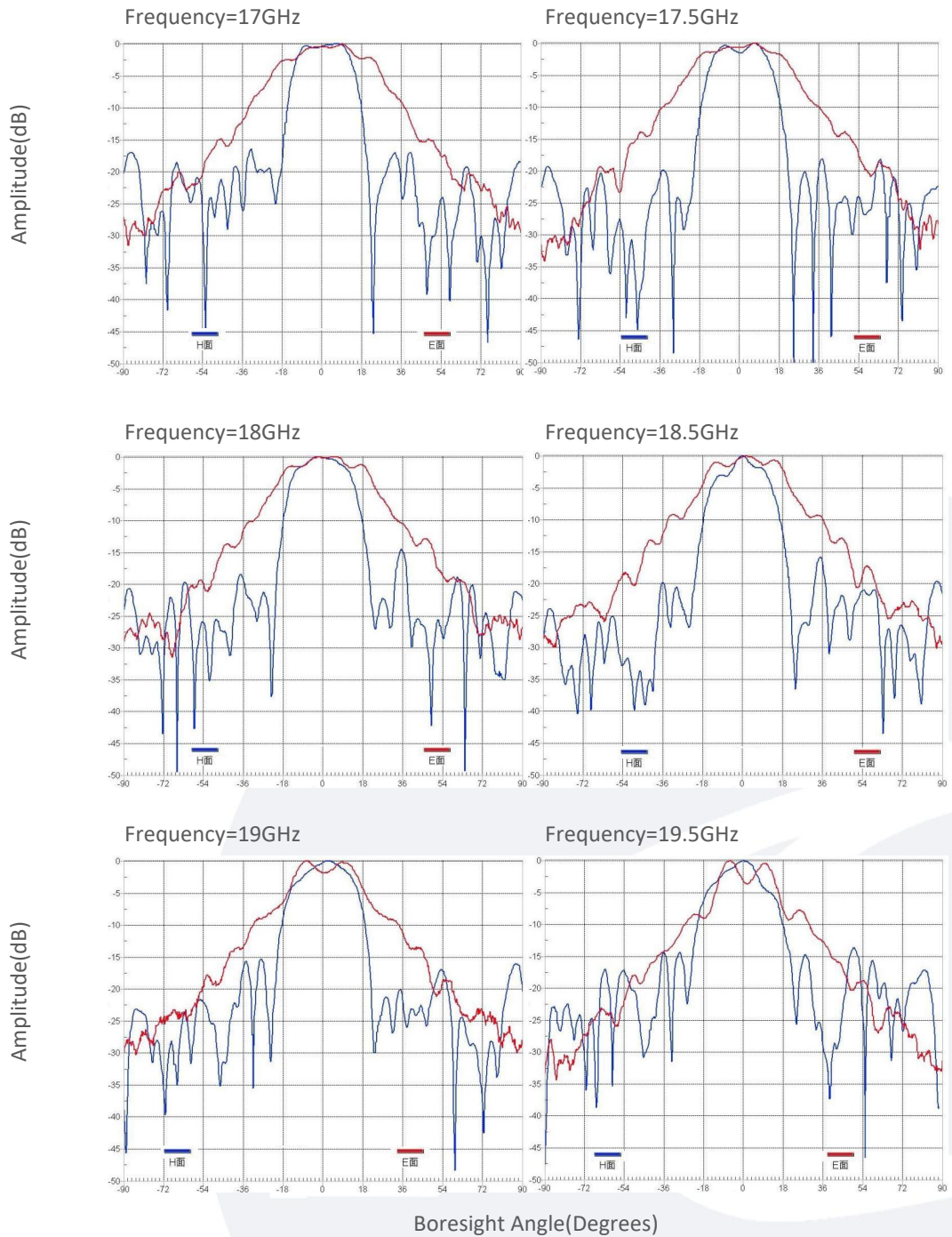

典型曲线 Typical Performance Data:

Pattern

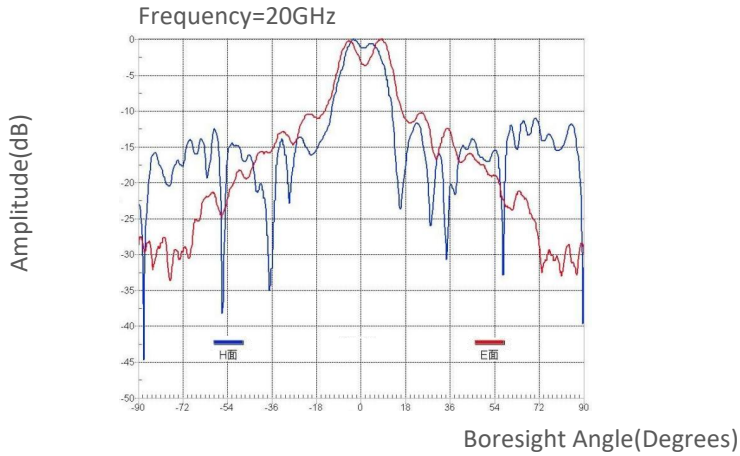

AF vs Frequency

