

**Part No: TAXXA100-N-4**

**N Attenuators • Male to Female • DC – 4GHz - 100 W**

**电气特性 ELECTRICAL**

- **Frequency Range** DC – 4GHz
- **Attenuation (dB)**
  - 3 ..... -0.6/+0.6dB
  - 6..... -0.6/+0.6dB
  - 10..... -0.6/+0.6dB
  - 20..... -0.5/+0.5dB
  - 30 ..... -0.5/+0.5dB
  - 40 ..... -0.5/+0.5dB
- **VSWR (MAX)** DC – 4GHz..... 1.2: 1
- **Impedance** 50 Ohms
- **RF Power Rating** 100Watts Average at 25°C

**机械特性 MECHANICAL**

- **Body Material:** Black, Finned Aluminum
- **Center conductor:** Gold-plated, Phosphor bronze
- **Connectors:** Nickel plated Brass
- **Weight:** 1100 g

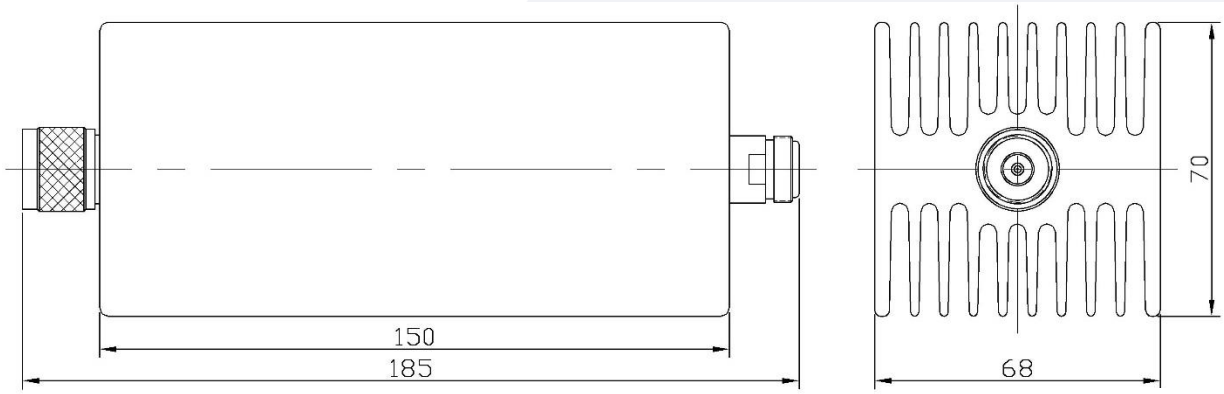

Unit:mm

**订货信息 ORDER**

