

## Y-Band Frequency Extender 170-260GHz /WR-4.3

**Model: TLSE-170260-0030-04**

TLSE-170260-0030-04 frequency extenders are a dedicated Test & Measurement solution for extending the range of your signal source to 170-260 GHz.

### Features:

- Frequency range: 170-260 GHz
- Output Power : 0dBm Typ
- Low power consumption

### Applications:

- Frequency Extension
- Antenna measurements
- Material characterisation

### Electrical Characteristics:

Parameter	Min	Typ	Max	Units
Frequency range	170		260	GHz
Output Power		0		dBm
Dynamic Range (Optional mechanical Attenuator)		30		dB
Input Frequency	9.44		14.44	GHz
Input Power	3	5	7	dBm
Multiplication Factor		18		
Harmonic Suppression		-20		dBc
Input VSWR		2		:1
Output VSWR		2		:1
Supply Voltage	100	220	240	V

### Mechanical Specifications:

Parameter	Value	Units
Input Connector	SMA Female	
Output Connector	WR-4.3/UG-387/U	
DC Bias	Power adapter: 100-240VAC	
Size	150*65*50	mm

### Absolute Maximum Ratings:

Parameter	Value
Supply Bias Voltage	+240 V AC
RF Input Power	+10 dBm
ESD sensitivity (HBm)	Class 0, passed 150V

### Outline Drawing:

Unit:mm

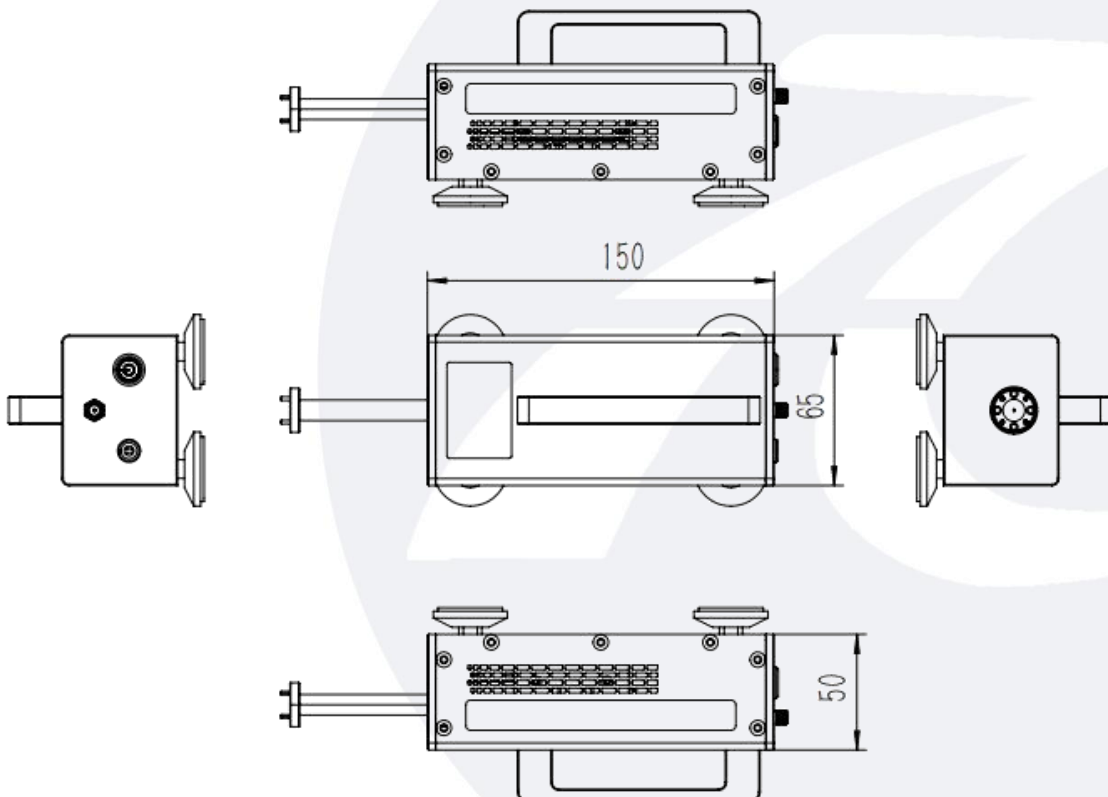

### Block Diagrams:

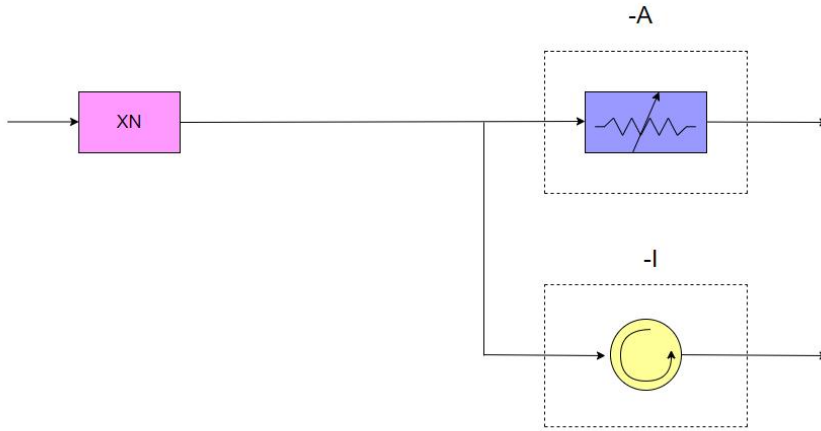

### Environmental Conditions:

Parameter	Min	Typ	Max	Units
Operating Temperature	-10		+65	°C
Non-operating Temperature	-45		+85	°C
Relative humidity		95		%
Altitude	10,000			feet
Shock / Vibration(MIL-STD-810F)	25g rms (15 degree 2KHz) endurance, 1 hour per axis			
Shock(non operating)	20G for 11msc half sin wave,3 axis both directions			

### Ordering Information:

Part Number	Description	Option		Revision
		Optional Mechanical Attenuator	Isolation	
TLSE-170260-0030-04	Y-Band Frequency Extender,X18,170-260GHz, Output Power: 0 dBm	-A	-I	Rev.1.2

### Components Included:

Part Number	Description	Quantity
TLACTDC-22012	AC-to-DC Power Adapter	1 PCS